

PILOT'S OPERATING HANDBOOK

PIPER CHEROKEE ARCHER II



FAA APPROVED IN NORMAL AND UTILITY CATEGORIES BASED ON CAR 3 AND FAR PART 21, SUBPART J. THIS HANDBOOK INCLUDES THE MATERIAL REQUIRED TO BE FURNISHED TO THE PILOT BY CAR 3 AND FAR PART 21, SUBPART J AND CONSTITUTES THE APPROVED AIRPLANE FLIGHT MANUAL AND MUST BE CARRIED IN THE AIRPLANE AT ALL TIMES.

PA-28-181
REPORT: VB-790

FAA APPROVED BY: Ward Evans
WARD EVANS
D.O.A. NO. SO-1
PIPER AIRCRAFT CORPORATION
VERO BEACH, FLORIDA

AIRPLANE SERIAL NO. 28-7890340

AIRPLANE REGISTRATION NO. LN-NPQ

DATE OF APPROVAL: JUNE 18, 1976



C of A No.: 1685
Approved by CAA, Norway
Date: 19 June, 1978

E. Fred. Olsen
E. Fred. Olsen
Head of
Aircraft Maintenance Section

HANDBOOK PART NO. 761 624



WARNING

EXTREME CARE MUST BE EXERCISED TO LIMIT THE USE OF THIS MANUAL TO APPLICABLE AIRCRAFT. THIS MANUAL REVISED AS INDICATED BELOW OR SUBSEQUENTLY REVISED IS VALID FOR USE WITH THE AIRPLANE IDENTIFIED ON THE FACE OF THE TITLE PAGE WHEN OFFICIALLY APPROVED. SUBSEQUENT REVISIONS SUPPLIED BY PIPER AIRCRAFT CORPORATION MUST BE PROPERLY INSERTED.

MODEL PA-28-181, CHEROKEE ARCHER II

PILOT'S OPERATING HANDBOOK, REPORT: VB-790 REVISION _____ 4 _____

PIPER AIRCRAFT CORPORATION
APPROVAL SIGNATURE AND STAMP _____

J. W. Walke 

Published by
PUBLICATIONS DEPARTMENT
Piper Aircraft Corporation
Issued: June 18, 1976

REPORT: VB-790

ii

TABLE OF CONTENTS

SECTION 1	GENERAL
SECTION 2	LIMITATIONS
SECTION 3	EMERGENCY PROCEDURES
SECTION 4	NORMAL PROCEDURES
SECTION 5	PERFORMANCE
SECTION 6	WEIGHT AND BALANCE
SECTION 7	DESCRIPTION AND OPERATION OF THE AIRPLANE AND ITS SYSTEMS
SECTION 8	AIRPLANE HANDLING, SERVICING AND MAINTENANCE
SECTION 9	SUPPLEMENTS
SECTION 10	OPERATING TIPS

APPLICABILITY

Application of this handbook is limited to the specific Piper PA-28-181 model airplane designated by serial number and registration number on the face of the title page of this handbook.

This handbook cannot be used for operational purposes unless kept in a current status.

REVISIONS

The information compiled in the Pilot's Operating Handbook will be kept current by revisions distributed to the airplane owners.

Revision material will consist of information necessary to update the text of the present handbook and/or to add information to cover added airplane equipment.

I. Revisions

Revisions will be distributed whenever necessary as complete page replacements or additions and shall be inserted into the handbook in accordance with the instructions given below:

1. Revision pages will replace only pages with the same page number.
2. Insert all additional pages in proper numerical order within each section.
3. Page numbers followed by a small letter shall be inserted in direct sequence with the same common numbered page.

II. Identification of Revised Material

Revised text and illustrations shall be indicated by a black vertical line along the outside margin of the page, opposite revised, added or deleted material. A line along the outside margin of the page opposite the page number will indicate that an entire page was added.

Black lines will indicate only current revisions with changes and additions to or deletions of existing text and illustrations. Changes in capitalization, spelling, punctuation or the physical location of material on a page will not be identified by symbols.

ORIGINAL PAGES ISSUED

The original pages issued for this handbook prior to revision are given below:

Title, ii through v, 1-1 through 1-14, 2-1 through 2-8, 3-1 through 3-12, 4-1 through 4-16, 5-1 through 5-28, 6-1 through 6-52, 7-1 through 7-26, 8-1 through 8-16, 9-1 through 9-14, 10-1 through 10-2.

PILOT'S OPERATING HANDBOOK LOG OF REVISIONS

Current Revisions to the PA-28-181 Cherokee Archer II Pilot's Operating Handbook, REPORT: VB-790 issued June 18, 1976

Revision Number and Code	Revised Pages	Description of Revision	FAA Approval Signature and Date
Rev. 1 - 761 624 (PR760804)	2-1 2-2 6-i 6-41 6-43	Revised "Never Exceed Speed" KIAS value. Revised Airspeed Indicator Markings. Revised report number at bottom of page. Revised Arm and Moment for item 177. Revised items 193, 195 and 197.	<i>Ward Evans</i> Ward Evans August 4, 1976
Rev. 2 - 761 624 (PR770120)	3-4 3-11 4-7 4-8 4-14 4-15 5-4 5-6 5-23 6-4 6-5 6-21 6-35 6-37 6-44 6-48 7-21 10-1 10-2	Revised Open Door procedure. Revised para. 3.27 info. Added Caution to para. 4.9; relocated material to page 4-8. Added relocated material from page 4-7. Added Note to para. 4.31. Revised stall speed in para. 4.35. Revised wording in para. 5.5 (c). Revised fuel quantity figure in para. 5.5 (g). Revised 55% & 75% range figures in Fig. 5-25. Added A & B values to Fig. 5-1. Revised weight and balance formula. Added Weight, Arm and Moment to item 29 a.; added item 29 b.; changed existing item 29 b. to 29 c. Revised item 79 Arm and Moment. Revised item 115 Dwg. 99002-5 to -8 and item 117 Dwg. 99003-5 to -7. Revised footnote. Revised item 257b. Arm and Moment. Added info to para. 7.25. Revised 10.3(c); relocated material to page 10-2. Added relocated material from page 10-1.	<i>Ward Evans</i> Ward Evans Jan. 20, 1977
Rev. 3 - 761 624 (PR770225)	1-6 3-11 4-4 4-9 6-4 6-49 7-25	Corrected to "Meteorological." Revised NOTE. Revised Hot Start procedure. Revised 4.13 (b). Revised Leveling Diagram illustration. Revised Dwg. Nos. of items 287 and 289. Added ELT test info.	<i>Ward Evans</i> Ward Evans Feb. 25, 1977

PILOT'S OPERATING HANDBOOK LOG OF REVISIONS (cont)

Revision Number and Code	Revised Pages	Description of Revision	FAA Approval Signature and Date
Rev. 4 - 761 624 (PR770712)	1-3	Added new propeller to 1.5 and added footnote.	
	1-11, 1-12,	Revised section 1.21, Conversion Factors.	
	1-13, 1-14		
	2-2	Added, new propeller to 2.7, item (j) and added footnote.	
	4-4	Revised Starting With External Power Source.	
	4-9	Revised item 4.13 (d) Starting Engine With External Power Source.	
	4-10	Added CAUTION.	
	5-9	Revised page nos.; revised titles; added pages; added figures.	
	5-19	Added ser. nos.	
	5-20	Relocated Fig. 5-19 to page 5-21; added new chart (Fig. 5-18).	
	5-21	Relocated Fig. 5-21 to page 5-23; added re-located Fig. 5-19; added ser. nos.	
	5-22	Relocated Fig. 5-23 to page 5-25; added new chart (Fig. 5-20).	
	5-23	Relocated Fig. 5-25 to page 5-27; added re-located Fig. 5-21; added ser. nos.	
	5-24	Relocated Fig. 5-27 to page 5-29; added new chart (Fig. 5-22).	
	5-25	Relocated Fig. 5-29 to page 5-30; added re-located Fig. 5-23; added ser. nos.	
	5-26	Relocated Fig. 5-31 to page 5-31; added new chart (Fig. 5-24).	
	5-27	Relocated Fig. 5-33 to page 5-32; added re-located Fig. 5-25; added ser. nos.	
	5-28	Relocated Fig. 5-35 to page 5-33; added new chart (Fig. 5-26).	
	5-29	Added page (added relocated Fig. 5-27).	
	5-30	Added page (added relocated Fig. 5-29).	
	5-31	Added page (added relocated Fig. 5-31).	
	5-32	Added page (added relocated Fig. 5-33).	
	5-33	Added page (added relocated Fig. 5-35).	
	5-34	Added page (int. blank).	
	6-17	Added item 3.	
	6-33	Added items 76 and 77.	
	6-45	Added item 223; renumbered items; re-located item.	
	6-46	Added relocated items; renumbered items; added new items; relocated items; removed footnotes; added footnote.	
6-47	Added relocated items; renumbered items; added new items; relocated items; added footnote.		

PILOT'S OPERATING HANDBOOK LOG OF REVISIONS (cont)

Revision Number and Code	Revised Pages	Description of Revision	FAA Approval Signature and Date
Rev. 4 - 761 624 (PR770712) (cont)	6-48	Added relocated items; renumbered items; added new items; revised item 277; relocated items; added footnotes.	<i>Ward Evans</i> Ward Evans July 12, 1977
	6-48a	Added page (added relocated items and new item).	
	6-48b	Added page.	
	6-49	Renumbered items; revised items 325 and 329.	
	6-50	Renumbered items; revised item 349.	
	7-1	Added new propeller model to para. 7.5.	
	7-18	Revised alternate static source description in para. 7.21.	

Revision Number and Code	Revised Pages	Description of Revision	FAA Approval Signature and Date
Rev. 8 - 761 624 (PR800523) (cont)	6-38 6-40 6-41 6-42 7-1 7-10 8-11 10-2	Relocated items 129 and 131 from pg. 6-37. Relocated items 169 thru 177 from pg. 6-41; Revised items 173 and 175. Moved items 169 thru 177 to pg. 6-40; added item 180; relocated item 183 from pg. 6-42. Moved item 183 to pg. 6-41. Revised para. 7.5. Revised para. 7.13. Revised para. 8.19. Added para. (j).	<i>Ward Evans</i> Ward Evans May 23, 1980
Rev. 9 - 761 624 (PR840330)	v 1-3 1-6. 1-7 2-1 2-2 3-i 3-1 4-i 4-3. 4-5. 4-6 4-8 4-12 4-14 4-15 6-1 6-3 6-6 6-7 6-9. 6-10 6-17 7-11 7-22 8-3 8-4 8-11 8-11a. 8-11b 9-13 10-i 10-1. 10-2	Revised Table of Contents Revised para. 1.7 Revised para. 1.19 Revised para. 2.1 Revised para. 2.7 Revised Table of Contents Revised para. 3.1 Revised Table of Contents Revised para. 4.5 Added Note Added Note Revised para. 4.29 Move para. 4.31 from 4-14 Revised para. 6.1 Revised para. 6.3 Revised para. 6.5 Revised Fig. 6-5 Revised Fig. 6-7 Revised para. 6.9 Added Caution Revised para. 7.31 Revised para. 8.3 Revised para. 8.5 Revised para. 8.21 Added new page Revised Sec. 3(a) Revised Table of Contents Changed Sec. Title	<i>Ward Evans</i> Ward Evans March 30, 1984

TABLE OF CONTENTS

SECTION 1

GENERAL

Paragraph No.		Page No.
1.1	Introduction	1-1
1.3	Engines	1-3
1.5	Propellers	1-3
1.7	Fuel	1-3
1.9	Oil	1-3
1.11	Maximum Weights	1-4
1.13	Standard Airplane Weights	1-4
1.15	Baggage Space	1-4
1.17	Specific Loadings	1-4
1.19	Symbols, Abbreviations and Terminology	1-5
1.21	Conversion Factors	1-11

5
824/8
2/1

SECTION I

GENERAL

1.1 INTRODUCTION

This Pilot's Operating Handbook is designed for maximum utilization as an operating guide for the pilot. It includes the material required to be furnished to the pilot by C.A.R. 3 and FAR Part 21, Subpart J. It also contains supplemental data supplied by the airplane manufacturer.

This handbook is not designed as a substitute for adequate and competent flight instruction, knowledge of current airworthiness directives, applicable federal air regulations or advisory circulars. It is not intended to be a guide for basic flight instruction or a training manual and should not be used for operational purposes unless kept in a current status.

Assurance that the airplane is in an airworthy condition is the responsibility of the owner. The pilot in command is responsible for determining that the airplane is safe for flight. The pilot is also responsible for remaining within the operating limitations as outlined by instrument markings, placards, and this handbook.

Although the arrangement of this handbook is intended to increase its in-flight capabilities, it should not be used solely as an occasional operating reference. The pilot should study the entire handbook to familiarize himself with the limitations, performance, procedures and operational handling characteristics of the airplane before flight.

The handbook has been divided into numbered (arabic) sections, each provided with a "finger-tip" tab divider for quick reference. The limitations and emergency procedures have been placed ahead of the normal procedures, performance and other sections to provide easier access to information that may be required in flight. The "Emergency Procedures" Section has been furnished with a red tab divider to present an instant reference to the section. Provisions for expansion of the handbook have been made by the deliberate omission of certain paragraph numbers, figure numbers, item numbers and pages noted as being left blank intentionally.

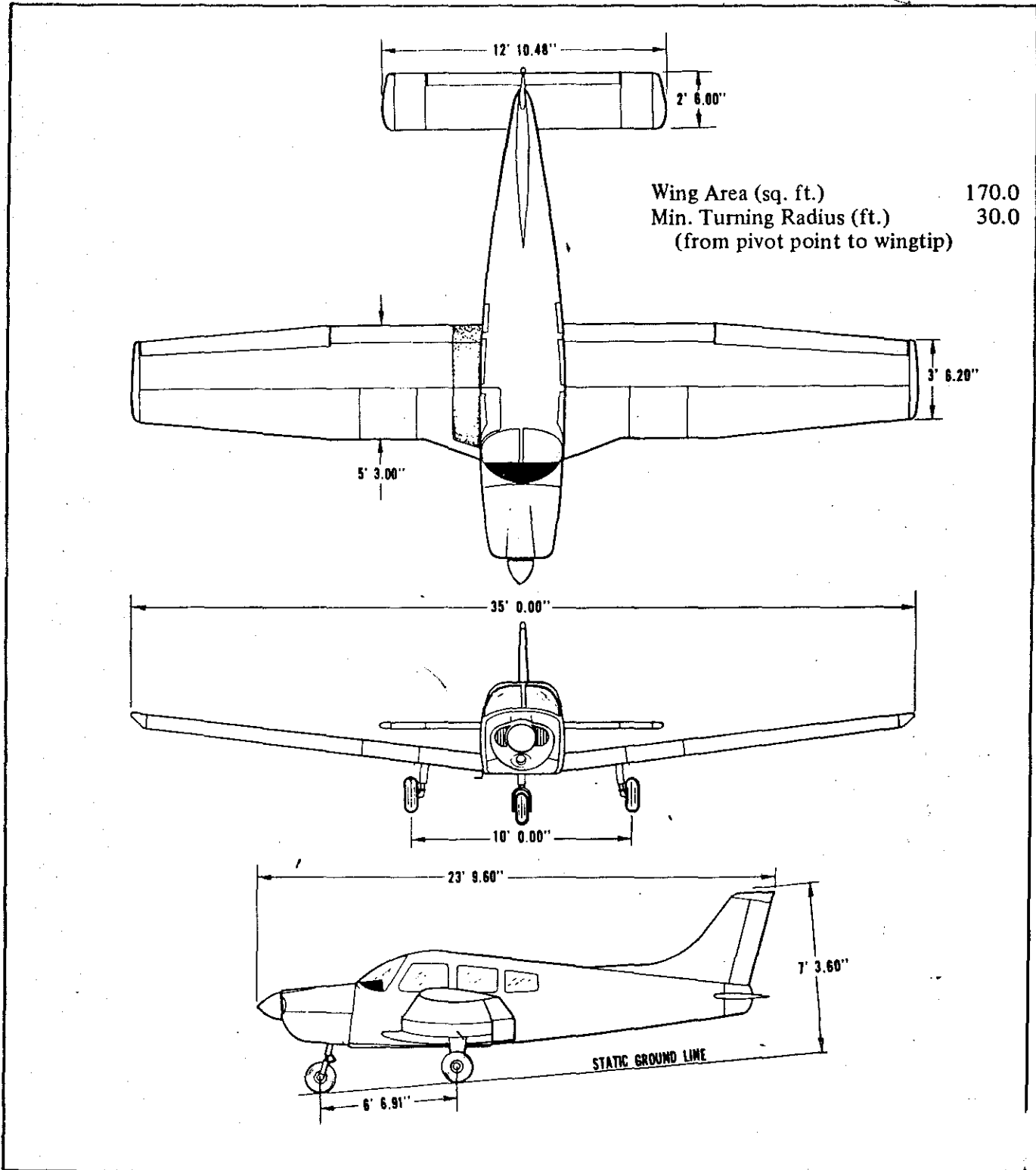

THREE VIEW

Figure 1-1

1.3 ENGINES

(a) Number of Engines	1
(b) Engine Manufacturer	Lycoming
(c) Engine Model Number	0-360-A4A or 0-360-A4M
(d) Rated Horsepower	180
(e) Rated Speed (rpm)	2700
(f) Bore (inches)	5.125
(g) Stroke (inches)	4.375
(h) Displacement (cubic inches)	361.0
(i) Compression Ratio	8.5:1
(j) Engine Type	Four Cylinder, Direct Drive, Horizontally Opposed, Air Cooled

1.5 PROPELLERS

(a) Number of Propellers	1
(b) Propeller Manufacturer	Sensenich
(c) Model	76EM8S5-0-60* or 76EM8S5-0-62 **
(d) Number of Blades	2
(e) Propeller Diameter (inches)	
(1) Maximum	76
(2) Minimum	76
(f) Propeller Type	Fixed Pitch

1.7 FUEL
AVGAS ONLY

(a) Fuel Capacity (U.S. gal) (total)	50
(b) Usable Fuel (U.S. gal) (total)	48
(c) Fuel Grade, Aviation	
(1) Minimum Octane	100/130 Green
(2) Specified Octane	100/130 Green
(3) Alternate Fuel	Refer to latest issue of Lycoming Instruction No. 1070.

1.9 OIL

(a) Oil Capacity (U.S. quarts)	8
(b) Oil Specification	Refer to latest issue of Lycoming Service Instruction 1014.
(c) Oil Viscosity per Average Ambient Temp. for Starting	
(1) Above 60°F	SINGLE MULTI
(2) 30°F to 90°F	S.A.E. 50 S.A.E. 40 or 50
(3) 0°F to 70°F	S.A.E. 40 S.A.E. 40
(4) Below 10°F	S.A.E. 30 S.A.E. 40 or 20W-30
	S.A.E. 20 S.A.E. 20W-30

*Serial nos. 28-7790001 through 28-7790607.
**Serial nos. 28-7890001 and up.

1.11 MAXIMUM WEIGHTS

	NORMAL	UTILITY
(a) Maximum Takeoff Weight (lbs)	2550	2130
(b) Maximum Landing Weight (lbs)	2550	2130
(c) Maximum Weights in Baggage Compartment	200	0

1.13 STANDARD AIRPLANE WEIGHTS*

(a) Standard Empty Weight (lbs): Weight of a standard airplane including unusable fuel, full operating fluids and full oil.	1416
(b) Maximum Useful Load (lbs): The difference between the Maximum Takeoff Weight and the Standard Empty Weight.	1134

1.15 BAGGAGE SPACE

(a) Compartment Volume (cubic feet)	24
(b) Entry Width (inches)	22
(c) Entry Height (inches)	20

1.17 SPECIFIC LOADINGS

(a) Wing Loading (lbs per sq ft)	15.0
(b) Power Loading (lbs per hp)	14.2

*These values are approximate and may vary from one aircraft to another. Refer to Figure 6-5 for the Standard Empty Weight value and Useful Load value to be used for C.G. calculations for the aircraft specified.

1.19 SYMBOLS, ABBREVIATIONS AND TERMINOLOGY

The following definitions are of symbols, abbreviations and terminology used throughout the handbook and those which may be of added operational significance to the pilot.

(a) General Airspeed Terminology and Symbols

CAS	Calibrated Airspeed means the indicated speed of an aircraft, corrected for position and instrument error. Calibrated airspeed is equal to true airspeed in standard atmosphere at sea level.
KCAS	Calibrated Airspeed expressed in "Knots."
GS	Ground Speed is the speed of an airplane relative to the ground.
IAS	Indicated Airspeed is the speed of an aircraft as shown on the airspeed indicator when corrected for instrument error. IAS values published in this handbook assume zero instrument error.
KIAS	Indicated Airspeed expressed in "Knots."
M	Mach Number is the ratio of true airspeed to the speed of sound.
TAS	True Airspeed is the airspeed of an airplane relative to undisturbed air which is the CAS corrected for altitude, temperature and compressability.
V_A	Maneuvering Speed is the maximum speed at which application of full available aerodynamic control will not overstress the airplane.
V_{FE}	Maximum Flap Extended Speed is the highest speed permissible with wing flaps in a prescribed extended position.
V_{NE}/M_{NE}	Never Exceed Speed or Mach Number is the speed limit that may not be exceeded at any time.
V_{NO}	Maximum Structural Cruising Speed is the speed that should not be exceeded except in smooth air and then only with caution.
V_S	Stalling Speed or the minimum steady flight speed at which the airplane is controllable.
V_{SO}	Stalling Speed or the minimum steady flight speed at which the airplane is controllable in the landing configuration.
V_X	Best Angle-of-Climb Speed is the airspeed which delivers the greatest gain of altitude in the shortest possible horizontal distance.
V_Y	Best Rate-of-Climb Speed is the airspeed which delivers the greatest gain in altitude in the shortest possible time.

(b) Meteorological Terminology

ISA	International Standard Atmosphere in which: The air is a dry perfect gas; The temperature at sea level is 15° Celsius (59° Fahrenheit); The pressure at sea level is 29.92 inches hg. (1013.2 mb); The temperature gradient from sea level to the altitude at which the temperature is -56.5° C (-69.7° F) is -0.00198° C (-0.003564° F) per foot and zero above that altitude.
OAT	Outside Air Temperature is the free air static temperature, obtained either from inflight temperature indications or ground meteorological sources, adjusted for instrument error and compressibility effects.
Indicated Pressure Altitude	The number actually read from an altimeter when the barometric subscale has been set to 29.92 inches of mercury (1013.2 millibars).
Pressure Altitude	Altitude measured from standard sea-level pressure (29.92 in. Hg) by a pressure or barometric altimeter. It is the indicated pressure altitude corrected for position and instrument error. In this handbook, altimeter instrument errors are assumed to be zero.
Station Pressure	Actual atmospheric pressure at field elevation.
Wind	The wind velocities recorded as variables on the charts of this handbook are to be understood as the headwind or tailwind components of the reported winds.

(c) Power Terminology

Takeoff Power	Maximum power permissible for takeoff.
Maximum Continuous Power	Maximum power permissible continuously during flight.
Maximum Climb Power	Maximum power permissible during climb.
Maximum Cruise Power	Maximum power permissible during cruise.

(d) Engine Instruments

EGT Gauge	Exhaust Gas Temperature Gauge
-----------	-------------------------------

(e) Airplane Performance and Flight Planning Terminology

Climb Gradient	The demonstrated ratio of the change in height during a portion of a climb, to the horizontal distance traversed in the same time interval.
Demonstrated Crosswind Velocity	The demonstrated crosswind velocity is the velocity of the crosswind component for which adequate control of the airplane during takeoff and landing was actually demonstrated during certification tests.
Accelerate-Stop Distance	The distance required to accelerate an airplane to a specified speed and, assuming failure of an engine at the instant that speed is attained, to bring the airplane to a stop.
Route Segment	A part of a route. Each end of that part is identified by: (1) a geographical location; or (2) a point at which a definite radio fix can be established.

(f) Weight and Balance Terminology

Reference Datum	An imaginary vertical plane from which all horizontal distances are measured for balance purposes.
Station	A location along the airplane fuselage usually given in terms of distance from the reference datum.
Arm	The horizontal distance from the reference datum to the center of gravity (C.G.) of an item.
Moment	The product of the weight of an item multiplied by its arm. (Moment divided by a constant is used to simplify balance calculations by reducing the number of digits.)
Center of Gravity (C.G.)	The point at which an airplane would balance if suspended. Its distance from the reference datum is found by dividing the total moment by the total weight of the airplane.
C.G. Arm	The arm obtained by adding the airplane's individual moments and dividing the sum by the total weight.
C.G. Limits	The extreme center of gravity locations within which the airplane must be operated at a given weight.
Usable Fuel	Fuel available for flight planning.
Unusable Fuel	Fuel remaining after a runout test has been completed in accordance with governmental regulations.
Standard Empty Weight	Weight of a standard airplane including unusable fuel, full operating fluids and full oil.
Basic Empty Weight	Standard empty weight plus optional equipment.
Payload	Weight of occupants, cargo and baggage.
Useful Load	Difference between takeoff weight, or ramp weight if applicable, and basic empty weight.
Maximum Ramp Weight	Maximum weight approved for ground maneuver. (It includes weight of start, taxi and run up fuel.)
Maximum Takeoff Weight	Maximum weight approved for the start of the takeoff run.
Maximum Landing Weight	Maximum weight approved for the landing touchdown.
Maximum Zero Fuel Weight	Maximum weight exclusive of usable fuel.

1.21 CONVERSION FACTORS

<u>MULTIPLY</u>	<u>BY</u>	<u>TO OBTAIN</u>	<u>MULTIPLY</u>	<u>BY</u>	<u>TO OBTAIN</u>	
acres	0.4047	ha	cubic inches (cu. in.)	16.39	cm ³	
	43560	sq. ft.		1.639×10^{-5}	m ³	
	0.0015625	sq. mi.		5.787×10^{-4}	cu. ft.	
atmospheres (atm)	76	cm Hg	cubic meters (m ³)	0.5541	fl. oz.	
	29.92	in. Hg		0.01639	l	
	1.0133	bar		4.329×10^{-3}	U.S. gal.	
	1.033	kg/cm ²		0.01732	U.S. qt.	
	14.70	lb./sq. in.				
	2116	lb./sq. ft.				
bars (bar)	0.98692	atm.	cubic meters per minute (m ³ /min.)	35.3147	cu. ft./min.	
	14.503768	lb./sq. in.				
British Thermal Unit (BTU)	0.2519958	kg-cal	cubic yards (cu. yd.)	27	cu. ft.	
centimeters (cm)	0.3937	in.		0.7646	m ³	
	0.032808	ft.		202	U.S. gal.	
centimeters of mercury at 0°C (cm Hg)	0.01316	atm	degrees (arc)	0.01745	radians	
	0.3937	in. Hg		degrees per second (deg./sec.)	0.01745	radians/sec.
	0.1934	lb./sq. in.				
	27.85	lb./sq. ft.				
135.95	kg/m ²					
centimeters per second (cm/sec.)	0.032808	ft./sec.	drams, fluid (dr. fl.)	0.125	fl. oz.	
	1.9685	ft./min.	drams, avdp. (dr. avdp.)	0.0625	oz. avdp.	
	0.02237	mph				
cubic centimeters (cm ³)	0.03381	fl. oz.	feet (ft.)	30.48	cm	
	0.06102	cu. in.		0.3048	m	
	3.531×10^{-5}	cu. ft.		12	in.	
	0.001	l		0.33333	yd.	
	2.642×10^{-4}	U.S. gal.		0.0606061	rod	
cubic feet (cu.ft.)	28317	cm ³	feet per minute (ft./min.)	1.894×10^{-4}	mi.	
	0.028317	m ³		1.645×10^{-4}	NM	
	1728	cu. in.		0.01136	mph	
	0.037037	cu. yd.		0.01829	km/hr.	
	7.481	U.S. gal.		0.508	cm/sec.	
	28.32	l		0.00508	m/sec.	
cubic feet per minute (cu. ft./min.)	0.472	l/sec.				
	0.028317	m ³ /min.				

SECTION 1
GENERAL

PIPER AIRCRAFT CORPORATION
PA-28-181, CHEROKEE ARCHER II

<u>MULTIPLY</u>	<u>BY</u>	<u>TO OBTAIN</u>	<u>MULTIPLY</u>	<u>BY</u>	<u>TO OBTAIN</u>
feet per second (ft./sec.)	0.6818 1.097 30.48 0.5921	mph km/hr. cm/sec. kts.	hectares (ha)	2.471 107639 10000	acres sq. ft. m ²
foot-pounds (ft.-lb.)	0.1383255 3.24 x 10 ⁻⁴	m-kg kg-cal	horsepower (hp)	33000 550 76.04 1.014	ft.-lb./min. ft.-lb./sec. m-kg/sec. metric hp
foot-pounds per minute (ft.-lb./min.)	3.030 x 10 ⁻⁵	hp	horsepower, metric	75 0.9863	m-kg/sec. hp
foot-pounds per second (ft.-lb./sec.)	1.818 x 10 ⁻⁵	hp	inches (in.)	25.40 2.540 0.0254 0.08333 0.027777	mm cm m ft. yd.
gallons, Imperial (Imperial gal.)	277.4 1.201 4.546	cu. in. U.S. gal. 1	inches of mercury at 0°C (in. Hg)	0.033421 0.4912 70.73 345.3 2.540 25.40	atm lb./sq. in. lb./sq. ft. kg/m ² cm Hg mm Hg
gallons, U.S. dry (U.S. gal. dry)	268.8 1.556 x 10 ⁻¹ 1.164 4.405	cu. in. cu. ft. U.S. gal. 1	inch-pounds (in.-lb.)	0.011521	m-kg
gallons, U.S. liquid (U.S. gal.)	231 0.1337 4.951 x 10 ⁻³ 3785.4 3.785 x 10 ⁻³ 3.785 0.83268 128	cu. in. cu. ft. cu. yd. cm ³ m ³ 1 Imperial gal. fl. oz.	kilograms (kg)	2.204623 35.27 1000	lb. oz. avdp. g
gallons per acre (gal./acre)	9.353	1/ha	kilogram-calories (kg-cal)	3.9683 3087 426.9	BTU ft.-lb. m-kg
grams (g)	0.001 0.3527 2.205 x 10 ⁻³	kg oz. avdp. lb.	kilograms per cubic meter (kg/m ³)	0.06243 0.001	lb./cu. ft. g/cm ³
grams per centimeter (g/cm)	0.1 6.721 x 10 ⁻² 5.601 x 10 ⁻³	kg/m lb./ft. lb./in.	kilograms per hectare (kg/ha)	0.892	lb./acre
grams per cubic centimeter (g/cm ³)	1000 0.03613 62.43	kg/m ³ lb./cu. in. lb./cu. ft.	kilograms per square centimeter (kg/cm ²)	0.9678 28.96 14.22 2048	atm in. Hg lb./sq. in. lb./sq. ft.

<u>MULTIPLY</u>	<u>BY</u>	<u>TO OBTAIN</u>	<u>MULTIPLY</u>	<u>BY</u>	<u>TO OBTAIN</u>
kilograms per square meter (kg/m ²)	2.896 x 10 ⁻³ 1.422 x 10 ⁻³ 0.2048	in. Hg lb./sq. in. lb./sq. ft.	meters per minute (m/min.)	0.06	km/hr.
kilometers (km)	1 x 10 ⁻⁵ 3280.8 0.6214 0.53996	cm ft. mi. NM	meters per second (m/sec.)	3.280840 196.8504 2.237 3.6	ft./sec. ft./min. mph km/hr.
kilometers per hour (km/hr.)	0.9113 58.68 0.53996 0.6214 0.27778 16.67	ft./sec. ft./min. kt mph m/sec. m/min.	microns	3.937 x 10 ⁻⁵	in.
knots (kt)	1 1.689 1.1516 1.852 51.48	nautical mph ft./sec. statute mph km/hr. m/sec.	miles, statute (mi.)	5280 1.6093 1609.3 0.8684	ft. km m NM
liters (l)	1000 61.02 0.03531 33.814 0.264172 0.2200 1.05669	cm ³ cu. in. cu. ft. fl. oz. U.S. gal. Imperial gal. qt.	miles per hour (mph)	44.7041 4.470 x 10 ⁻¹ 1.467 88 1.6093 0.8684	cm/sec. m/sec. ft./sec. ft./min. km/hr. kt
liters per hectare (l/ha)	13.69 0.107	fl. oz./acre gal./acre	miles per hour square (m/hr. sq.)	2.151	ft./sec. sq.
liters per second (l/sec.)	2.12	cu. ft./min.	millibars	2.953 x 10 ⁻²	in. Hg
meters (m)	39.37 3.280840 1.0936 0.198838 6.214 x 10 ⁻⁴ 5.3996 x 10 ⁻⁴	in. ft. yd. rod mj. NM	millimeters (mm)	0.03937	in.
meter-kilogram (m-kg)	7.23301 86.798	ft.-lb. in.-lb.	millimeters of mercury at 0°C (mm Hg)	0.03937	in. Hg
			nautical miles (NM)	6080 1.1516 1852 1.852	ft. statute mi. m km
			ounces, avdp. (oz. avdp.)	28.35 16	g dr. avdp.
			ounces, fluid (fl. oz.)	8 29.57 1.805 0.0296 0.0078	dr. fl. cm ³ cu. in. l U.S. gal.

**SECTION 1
GENERAL**

**PIPER AIRCRAFT CORPORATION
PA-23-181, CHEROKEE ARCHER II**

<u>MULTIPLY</u>	<u>BY</u>	<u>TO OBTAIN</u>
ounces, fluid per acre (fl. oz./acre)	0.073	l/ha
pounds (lb.)	0.453592 453.6 3.108×10^{-2}	kg g slug
pounds per acre (lb./acre)	1.121	kg/ha
pounds per cubic foot (lb./cu. ft.)	16.02	kg/m ³
pounds per cubic inch (lb./cu. in.)	1728 27.68	lb./cu. ft. g/cm ³
pounds per square foot (lb./sq. ft.)	0.1414 4.88243 4.725×10^{-4}	in. Hg kg/m ² atm
pounds per square inch (psi or lb./sq. in.)	5.1715 2.036 0.06804 0.0689476 703.1	cm Hg in. Hg atm bar kg/m ²
quart, U.S. (qt.)	0.94635 57.749	l cu. in.
radians	57.30 0.1592	deg. (arc) rev.
radians per second (radians/sec.)	57.30 0.1592 9.549	deg./sec. rev./sec. rpm
revolutions (rev.)	6.283	radians
revolutions per minute (rpm or rev./min.)	0.1047	radians/sec.
revolutions per second (rev./sec.)	6.283	radians/sec.

<u>MULTIPLY</u>	<u>BY</u>	<u>TO OBTAIN</u>
rod	16.5 5.5 5.029	ft. yd. m
slug	32.174	lb.
square centimeters (cm ²)	0.1550 0.001076	sq. in. sq. ft.
square feet (sq. ft.)	929 0.092903 144 0.1111 2.296×10^{-5}	cm ² m ² sq. in. sq. yd. acres
square inches (sq. in.)	6.4516 6.944×10^{-3}	cm ² sq. ft.
square kilometers (km ²)	0.3861	sq. mi.
square meters (m ²)	10.76391 1.196 0.0001	sq. ft. sq. yd. ha
square miles (sq. mi.)	2.590 640	km ² acres
square rods (sq. rods)	30.25	sq. yd.
square yards (sq. yd.)	0.8361 9 0.0330579	m ² sq. ft. sq. rods
yards (yd.)	0.9144 3 36 0.181818	m ft. in. rod

TABLE OF CONTENTS

SECTION 2

LIMITATIONS

Paragraph No.		Page No.
2.1	General	2-1
2.3	Airspeed Limitations	2-1
2.5	Airspeed Indicator Markings	2-2
2.7	Power Plant Limitations	2-2
2.9	Power Plant Instrument Markings	2-3
2.11	Weight Limits	2-3
2.13	Center of Gravity Limits	2-4
2.15	Maneuver Limits	2-4
2.17	Flight Load Factors	2-4
2.19	Types of Operations	2-5
2.21	Fuel Limitations	2-5
2.23	Placards	2-7

SECTION 2
LIMITATIONS

2.1 GENERAL

This section provides the "FAA Approved" operating limitations, instrument markings, color coding and basic placards necessary for the operation of the airplane and its systems.

This airplane must be operated as a normal or utility category airplane in compliance with the operating limitations stated in the form of placards and markings and those given in this section and this complete handbook.

Limitations associated with those optional systems and equipment which require handbook supplements can be found in Section 9 (Supplements).

2.3 AIRSPEED LIMITATIONS

SPEED	KIAS	KCAS
Never Exceed Speed (V_{NE}) - Do not exceed this speed in any operation.	154	148
Maximum Structural Cruising Speed (V_{NO}) - Do not exceed this speed except in smooth air and then only with caution.	125	121
Design Maneuvering Speed (V_A) - Do not make full or abrupt control movements above this speed.		
At 2550 LBS. G.W.	113	111
At 1634 LBS. G.W.	89	89

CAUTION

Maneuvering speed decreases at lighter weight as the effects of aerodynamic forces become more pronounced. Linear interpolation may be used for intermediate gross weights. Maneuvering speed should not be exceeded while operating in rough air.

Maximum Flaps Extended Speed (V_{FE}) - Do not exceed this speed with the flaps extended.	102	100
---	-----	-----

2.5 AIRSPEED INDICATOR MARKINGS

MARKING	IAS
Red Radial Line (Never Exceed)	(154 KTS)
Yellow Arc (Caution Range - Smooth Air Only)	(125 KTS to 154 KTS)
Green Arc (Normal Operating Range)	(55 KTS to 125 KTS)
White Arc (Flap Down)	(49 KTS to 102 KTS)

2.7 POWER PLANT LIMITATIONS

(a) Number of Engines	1
(b) Engine Manufacturer	Lycoming
(c) Engine Model No.	0360-A4A or 0-360-A4M with carburetor setting 10-3878
(d) Engine Operating Limits	
(1) Maximum Horsepower	180
(2) Maximum Rotation Speed (RPM)	2700
(3) Maximum Oil Temperature	245°F
(e) Oil Pressure	
Minimum (red line)	25 PSI
Maximum (red line)	90 PSI
(f) Fuel Pressure	
Minimum (red line)	.5 PSI
Maximum (red line)	8 PSI
(g) Fuel Grade (AVGAS ONLY) (minimum octane)	100/130 - Green
(h) Number of Propellers	1
(i) Propeller Manufacturer	Sensenich
(j) Propeller Model	<u>76EM8S5-0-60*</u> or <u>76EM8S5-0-62**</u>
(k) Propeller Diameter	
Minimum	76 IN.
Maximum	76 IN.
(l) Propeller Tolerance (static RPM at maximum permissible throttle setting)	Not above 2425 RPM* Not below 2325 RPM* Not above 2375 RPM** } NPQ Not below 2275 RPM** }

No additional tolerance permitted.

*Serial nos. 28-7790001 through 28-7790607.

**Serial nos. 28-7890001 and up.

2.9 POWER PLANT INSTRUMENT MARKINGS

(a) Tachometer	
Green Arc (Normal Operating Range)	500 to 2700 RPM
Red Line (Maximum Continuous Power)	2700 RPM
(b) Oil Temperature	
Green Arc (Normal Operating Range)	75° to 245° F
Red Line (Maximum)	245° F
(c) Oil Pressure	
Green Arc (Normal Operating Range)	60 PSI to 90 PSI
Yellow Arc (Caution Range) (Idle)	25 PSI to 60 PSI
Red Line (Minimum)	25 PSI
Red Line (Maximum)	90 PSI
(d) Fuel Pressure	
Green Arc (Normal Operating Range)	.5 PSI to 8 PSI
Red Line (Minimum)	.5 PSI
Red Line (Maximum)	8 PSI

2.11 WEIGHT LIMITS

	NORMAL	UTILITY
(a) Maximum Weight	2550 LBS	1950 LBS
(b) Maximum Baggage	200 LBS	0 LBS

NOTE

Refer to Section 5 (Performance) for maximum weight as limited by performance.

2.13 CENTER OF GRAVITY LIMITS

(a) Normal Category

Weight Pounds	Forward Limit Inches Aft of Datum	Rearward Limit Inches Aft of Datum
2550	88.6	93.0
2050 (and less)	82.0	93.0

(b) Utility Category

Weight Pounds	Forward Limit Inches Aft of Datum	Rearward Limit Inches Aft of Datum
1950 (and less)	82.0	86.5

NOTES

Straight line variation between points given.

The datum used is 78.4 inches ahead of the wing leading edge at the inboard intersection of the straight and tapered section.

It is the responsibility of the airplane owner and the pilot to insure that the airplane is properly loaded. See Section 6 (Weight and Balance) for proper loading instructions.

2.15 MANEUVER LIMITS

- (a) Normal Category - All acrobatic maneuvers including spins prohibited.
- (b) Utility Category - Approved maneuvers for bank angles exceeding 60°.

	Entry Speed
Steep Turns	113 KIAS
Lazy Eights	113 KIAS
Chandelles	113 KIAS

2.17 FLIGHT LOAD FACTORS

	NORMAL	UTILITY
(a) Positive Load Factor (Maximum)	3.8 G	4.4 G
(b) Negative Load Factor (Maximum)	No inverted maneuvers approved	

THIS PAGE INTENTIONALLY LEFT BLANK

2.23 PLACARDS

In full view of the pilot:

“THIS AIRPLANE MUST BE OPERATED AS A NORMAL OR UTILITY CATEGORY AIRPLANE IN COMPLIANCE WITH THE OPERATING LIMITATIONS STATED IN THE FORM OF PLACARDS, MARKINGS AND MANUALS.

ALL MARKINGS AND PLACARDS ON THIS AIRPLANE APPLY TO ITS OPERATION AS A UTILITY CATEGORY AIRPLANE. FOR NORMAL AND UTILITY CATEGORY OPERATION, REFER TO THE PILOT'S OPERATING HANDBOOK.

NO ACROBATIC MANEUVERS ARE APPROVED FOR NORMAL CATEGORY OPERATIONS. SPINS ARE PROHIBITED FOR NORMAL AND UTILITY CATEGORY.”

In full view of the pilot, the following takeoff and landing check lists will be installed:

TAKEOFF CHECK LIST

Fuel on proper tank
Electric fuel pump on
Engine gauges checked
Flaps - set
Carb heat off

Mixture set
Seat backs erect

Fasten belts/harness
Trim tab - set
Controls - free
Door - latched
Air Conditioner - off

LANDING CHECK LIST

Fuel on proper tank
Mixture rich
Electric fuel pump on

Seat back erect

Flaps - set (102 KIAS max.)
Fasten belts/harness
Air Conditioner - off

The “AIR COND OFF” item in the above takeoff and landing check lists is mandatory for air conditioned aircraft only.

In full view of the pilot, in the area of the air conditioner control panel when the air conditioner is installed:

“WARNING – AIR CONDITIONER MUST BE OFF TO INSURE NORMAL TAKEOFF CLIMB PERFORMANCE.”

Adjacent to upper door latch:

“ENGAGE LATCH BEFORE FLIGHT.”

On inside of the baggage compartment door:

“BAGGAGE MAXIMUM 200 LBS”
“UTILITY CATEGORY OPERATION - NO BAGGAGE OR AFT PASSENGERS ALLOWED. NORMAL CATEGORY OPERATION - SEE PILOT'S OPERATING HANDBOOK WEIGHT AND BALANCE SECTION FOR BAGGAGE AND AFT PASSENGER LIMITATIONS.”

In full view of the pilot:

“MANEUVERING SPEED 113 KIAS AT 2550 LBS. (SEE P.O.H.)”

“UTILITY CATEGORY OPERATION - NO AFT PASSENGERS ALLOWED.”

“DEMONSTRATED CROSS WIND COMPONENT - 17 KTS.”

On the instrument panel in full view of the pilot when the oil cooler winterization kit is installed:

“OIL COOLER WINTERIZATION PLATE TO BE REMOVED WHEN AMBIENT TEMPERATURE EXCEEDS 50°F.”

In full view of the pilot:

“UTILITY CATEGORY OPERATION ONLY.”

- (1) NO AFT PASSENGERS ALLOWED.
- (2) ACROBATIC MANEUVERS ARE LIMITED TO THE FOLLOWING:

	ENTRY SPEED
SPINS PROHIBITED	
STEEP TURNS	113 KIAS
LAZY EIGHTS	113 KIAS
CHANDELLES	113 KIAS

On the instrument panel in full view of the pilot:

“WARNING – TURN OFF STROBE LIGHTS WHEN TAXIING IN VICINITY OF OTHER AIRCRAFT, OR DURING FLIGHT THROUGH CLOUD, FOG OR HAZE.”

TABLE OF CONTENTS
SECTION 3
EMERGENCY PROCEDURES

Paragraph No.		Page No.
3.1	General	3-1
3.3	Emergency Procedures Check List	3-3
	Engine Fire During Start	3-3
	Engine Power Loss During Takeoff	3-3
	Engine Power Loss In Flight	3-3
	Power Off Landing	3-3
	Fire In Flight	3-3
	Loss Of Oil Pressure	3-3
	Loss Of Fuel Pressure	3-4
	High Oil Temperature	3-4
	Alternator Failure	3-4
	Spin Recovery	3-4
	Open Door	3-4
	Carburetor Icing	3-4
	Engine Roughness	3-4
3.5	Amplified Emergency Procedures (General)	3-7
3.7	Engine Fire During Start	3-7
3.9	Engine Power Loss During Takeoff	3-7
3.11	Engine Power Loss In Flight	3-8
3.13	Power Off Landing	3-8
3.15	Fire In Flight	3-9
3.17	Loss Of Oil Pressure	3-9
3.19	Loss Of Fuel Pressure	3-10
3.21	High Oil Temperature	3-10
3.23	Alternator Failure	3-10
3.25	Spin Recovery	3-10
3.27	Open Door	3-11
3.28	Carburetor Icing	3-11
3.29	Engine Roughness	3-11

SECTION 3
EMERGENCY PROCEDURES

3.1 GENERAL

The recommended procedures for coping with various types of emergencies and critical situations are provided by this section. All of required (FAA regulations) emergency procedures and those necessary for the operation of the airplane as determined by the operating and design features of the airplane are presented.

Emergency procedures associated with those optional systems and equipment which require handbook supplements are provided in Section 9 (Supplements).

The first portion of this section consists of an abbreviated emergency check list which supplies an action sequence for critical situations with little emphasis on the operation of systems.

The remainder of the section is devoted to amplified emergency procedures containing additional information to provide the pilot with a more complete understanding of the procedures.

These procedures are suggested as the best course of action for coping with the particular condition described, but are not a substitute for sound judgment and common sense. Pilots should familiarize themselves with the procedures given in this section and be prepared to take appropriate action should an emergency arise.

Most basic emergency procedures, such as power off landings, are a normal part of pilot training. Although these emergencies are discussed here, this information is not intended to replace such training, but only to provide a source of reference and review, and to provide information on procedures which are not the same for all aircraft. It is suggested that the pilot review standard emergency procedures periodically to remain proficient in them.

THIS PAGE INTENTIONALLY LEFT BLANK

3.3 EMERGENCY PROCEDURES CHECK LIST

ENGINE FIRE DURING START

Starter crank engine
Mixture idle cut-off
Throttle open
Electric fuel pump OFF
Fuel selector OFF
Abandon if fire continues

ENGINE POWER LOSS DURING TAKEOFF

If sufficient runway remains for a normal landing,
land straight ahead.

If insufficient runway remains:
Maintain safe airspeed
Make only shallow turn to avoid obstructions
Flaps as situation requires

If sufficient altitude has been gained to attempt a
restart:

Maintain safe airspeed
Fuel selector switch to tank
containing fuel

Electric fuel pump check ON
Mixture check RICH
Carburetor heat ON
Primer locked

If power is not regained, proceed with power off
landing.

ENGINE POWER LOSS IN FLIGHT

Fuel selector switch to tank
containing fuel

Electric fuel pump ON
Mixture RICH
Carburetor heat ON
Engine gauges check for indication
of cause of power loss

Primer check locked

If no fuel pressure is indicated, check tank selector
position to be sure it is on a tank containing fuel.

When power is restored:

Carburetor heat OFF
Electric fuel pump OFF

If power is not restored prepare for power off
landing.

1 Trim for 76 KIAS

POWER OFF LANDING

Locate suitable field.
Establish spiral pattern.
1000 ft. above field at downwind position for
normal landing approach.

When field can easily be reached slow to 66 KIAS
for shortest landing.

Touchdowns should normally be made at lowest
possible airspeed with full flaps.

When committed to landing:

Ignition OFF
Master switch OFF
Fuel selector OFF
Mixture idle cut-off
Seat belt and harness tight

FIRE IN FLIGHT

Source of fire check

Electrical fire (smoke in cabin):

Master switch OFF
Vents open
Cabin heat OFF
Land as soon as practicable.

Engine fire:

Fuel selector OFF
Throttle CLOSED
Mixture idle cut-off
Electric fuel pump check OFF
Heater and defroster OFF
Proceed with power off landing procedure.

LOSS OF OIL PRESSURE

Land as soon as possible and investigate cause.
Prepare for power off landing.

LOSS OF FUEL PRESSURE

Electric fuel pumpON
Fuel selectorcheck on full tank

HIGH OIL TEMPERATURE

Land at nearest airport and investigate the problem.
Prepare for power off landing.

ALTERNATOR FAILURE

Verify failure
Reduce electrical load as much as possible.
Alternator circuit breakerscheck
Alt switchOFF (for 1 second),
then on

If no output:
Alt switchOFF

Reduce electrical load and land as soon as practical.

SPIN RECOVERY

Throttle idle
Ailerons neutral
Rudder full opposite to
direction of rotation
Control wheelfull forward
Rudder neutral (when
rotation stops)
Control wheelas required to smoothly
regain level flight altitude

OPEN DOOR

If both upper and side latches are open, the door
will trail slightly open and airspeeds will be reduced
slightly.

To close the door in flight:

Slow airplane to 87 KIAS
Cabin ventsclose
Storm windowopen

If upper latch is openlatch
If side latch is openpull on armrest while
moving latch handle
to latched position

If both latches are openlatch side latch
then top latch

CARBURETOR ICING

Carburetor Heat ON
Mixture Adjust for Max. Smoothness

ENGINE ROUGHNESS

Carburetor heatON

If roughness continues after one min:

Carburetor heatOFF
Mixtureadjust for max.
smoothness

Electric fuel pumpON
Fuel selectorswitch tanks
Engine gaugescheck
Magneto switch“L” then “R”
then “BOTH”

If operation is satisfactory on either one, continue
on that magneto at reduced power and full “RICH”
mixture to first airport.

Prepare for power off landing.

3.5 AMPLIFIED EMERGENCY PROCEDURES (GENERAL)

The following paragraphs are presented to supply additional information for the purpose of providing the pilot with a more complete understanding of the recommended course of action and probable cause of an emergency situation.

3.7 ENGINE FIRE DURING START

Engine fires during start are usually the result of overpriming. The first attempt to extinguish the fire is to try to start the engine and draw the excess fuel back into the induction system.

If a fire is present before the engine has started, move the mixture control to idle cut-off, open the throttle and crank the engine. This is an attempt to draw the fire back into the engine.

If the engine has started, continue operating to try to pull the fire into the engine.

In either case (above), if fire continues more than a few seconds, the fire should be extinguished by the best available external means.

The fuel selector valves should be "OFF" and the mixture at idle cut-off if an external fire extinguishing method is to be used.

3.9 ENGINE POWER LOSS DURING TAKEOFF

The proper action to be taken if loss of power occurs during takeoff will depend on the circumstances of the particular situation.

If sufficient runway remains to complete a normal landing, land straight ahead.

If insufficient runway remains, maintain a safe airspeed and make only a shallow turn if necessary to avoid obstructions. Use of flaps depends on the circumstances. Normally, flaps should be fully extended for touchdown.

If sufficient altitude has been gained to attempt a restart, maintain a safe airspeed and switch the fuel selector to another tank containing fuel. Check the electric fuel pump to insure that it is "ON" and that the mixture is "RICH." The carburetor heat should be "ON."

If engine failure was caused by fuel exhaustion, power will not be regained after switching fuel tanks until the empty fuel lines are filled. This may require up to ten seconds.

If power is not regained, proceed with the Power Off Landing procedure (refer to the emergency check list and paragraph 3.13).

3.11 ENGINE POWER LOSS IN FLIGHT

Complete engine power loss is usually caused by fuel flow interruption and power will be restored shortly after fuel flow is restored. If power loss occurs at a low altitude, the first step is to prepare for an emergency landing (refer to paragraph 3.13). An airspeed of at least 76 KIAS should be maintained.

If altitude permits, switch the fuel selector to another tank containing fuel and turn the electric fuel pump "ON." Move the mixture control to "RICH" and the carburetor heat to "ON." Check the engine gauges for an indication of the cause of the power loss. Check to insure the primer is locked. If no fuel pressure is indicated, check the tank selector position to be sure it is on a tank containing fuel.

When power is restored move the carburetor heat to the "OFF" position and turn "OFF" the electric fuel pump.

If the preceding steps do not restore power, prepare for an emergency landing.

If time permits, turn the ignition switch to "L" then to "R" then back to "BOTH." Move the throttle and mixture control levers to different settings. This may restore power if the problem is too rich or too lean a mixture or if there is a partial fuel system restriction. Try other fuel tanks. Water in the fuel could take some time to be used up, and allowing the engine to windmill may restore power. If power is due to water, fuel pressure indications will be normal.

If engine failure was caused by fuel exhaustion power will not be restored after switching fuel tanks until the empty fuel lines are filled. This may require up to ten seconds.

If power is not regained, proceed with the Power Off Landing procedure (refer to the emergency check list and paragraph 3.13).

3.13 POWER OFF LANDING

If loss of power occurs at altitude, trim the aircraft for best gliding angle 76 KIAS (Air Cond. off) and look for a suitable field. If measures taken to restore power are not effective, and if time permits, check your charts for airports in the immediate vicinity; it may be possible to land at one if you have sufficient altitude. If possible, notify the FAA by radio of your difficulty and intentions. If another pilot or passenger is aboard, let him help.

When you have located a suitable field, establish a spiral pattern around this field. Try to be at 1000 feet above the field at the downwind position, to make a normal landing approach. When the field can easily be reached, slow to 66 KIAS with flaps down for the shortest landing. Excess altitude may be lost by widening your pattern, using flaps or slipping, or a combination of these.

Touchdown should normally be made at the lowest possible airspeed.

When committed to a landing, close the throttle control and shut "OFF" the master and ignition switches. Flaps may be used as desired. Turn the fuel selector valve to "OFF" and move the mixture to idle cut-off. The seat belts and shoulder harness (if installed) should be tightened. Touchdown should be normally made at the lowest possible airspeed.

3.15 FIRE IN FLIGHT

The presence of fire is noted through smoke, smell and heat in the cabin. It is essential that the source of the fire be promptly identified through instrument readings, character of the smoke, or other indications since the action to be taken differs somewhat in each case.

Check for the source of the fire first.

If an electrical fire is indicated (smoke in the cabin), the master switch should be turned "OFF." The cabin vents should be opened and the cabin heat turned "OFF." A landing should be made as soon as possible.

If an engine fire is present, switch the fuel selector to "OFF" and close the throttle. The mixture should be at idle cut-off. Turn the electric fuel pump "OFF." In all cases, the heater and defroster should be "OFF." If radio communication is not required, select master switch "OFF." Proceed with power off landing procedure.

NOTE

The possibility of an engine fire in flight is extremely remote. The procedure given is general and pilot judgment should be the determining factor for action in such an emergency.

3.17 LOSS OF OIL PRESSURE

Loss of oil pressure may be either partial or complete. A partial loss of oil pressure usually indicates a malfunction in the oil pressure regulating system, and a landing should be made as soon as possible to investigate the cause and prevent engine damage.

A complete loss of oil pressure indication may signify oil exhaustion or may be the result of a faulty gauge. In either case, proceed toward the nearest airport, and be prepared for a forced landing. If the problem is not a pressure gauge malfunction, the engine may stop suddenly. Maintain altitude until such time as a dead stick landing can be accomplished. Don't change power settings unnecessarily, as this may hasten complete power loss.

Depending on the circumstances, it may be advisable to make an off airport landing while power is still available, particularly if other indications of actual oil pressure loss, such as sudden increases in temperatures, or oil smoke, are apparent, and an airport is not close.

If engine stoppage occurs, proceed with Power Off Landing.

3.19 LOSS OF FUEL PRESSURE

If loss of fuel pressure occurs, turn "ON" the electric fuel pump and check that the fuel selector is on a full tank.

If the problem is not an empty tank, land as soon as practical and have the engine-driven fuel pump and fuel system checked.

3.21 HIGH OIL TEMPERATURE

An abnormally high oil temperature indication may be caused by a low oil level, an obstruction in the oil cooler, damaged or improper baffle seals, a defective gauge, or other causes. Land as soon as practical at an appropriate airport and have the cause investigated.

A steady, rapid rise in oil temperature is a sign of trouble. Land at the nearest airport and let a mechanic investigate the problem. Watch the oil pressure gauge for an accompanying loss of pressure.

3.23 ALTERNATOR FAILURE

Loss of alternator output is detected through zero reading on the ammeter. Before executing the following procedure, insure that the reading is zero and not merely low by actuating an electrically powered device, such as the landing light. If no increase in the ammeter reading is noted, alternator failure can be assumed.

The electrical load should be reduced as much as possible. Check the alternator circuit breakers for a popped circuit.

The next step is to attempt to reset the overvoltage relay. This is accomplished by moving the "ALT" switch to "OFF" for one second and then to "ON." If the trouble was caused by a momentary overvoltage condition (16.5 volts and up) this procedure should return the ammeter to a normal reading.

If the ammeter continues to indicate "O" output, or if the alternator will not remain reset, turn off the "ALT" switch, maintain minimum electrical load and land as soon as practical. All electrical load is being supplied by the battery.

3.25 SPIN RECOVERY

Intentional spins are prohibited in this airplane. If a spin is inadvertently entered, immediately move the throttle to idle and the ailerons to neutral.

Full rudder should then be applied opposite to the direction of rotation followed by control wheel full forward. When the rotation stops, neutralize the rudder and ease back on the control wheel as required to smoothly regain a level flight attitude.

3.27 OPEN DOOR

The cabin door on the Cherokee is double latched, so the chances of its springing open in flight at both the top and side are remote. However, should you forget the upper latch, or not fully engage the side latch, the door may spring partially open. This will usually happen at takeoff or soon afterward. A partially open door will not affect normal flight characteristics, and a normal landing can be made with the door open.

If both upper and side latches are open, the door will trail slightly open, and airspeed will be reduced slightly.

To close the door in flight, slow the airplane to 87 KIAS, close the cabin vents and open the storm window. If the top latch is open, latch it. If the side latch is open, pull on the armrest while moving the latch handle to the latched position. If both latches are open, close the side latch then the top latch.

3.29 ENGINE ROUGHNESS

Engine roughness is usually due to carburetor icing which is indicated by a drop in RPM, and may be accompanied by a slight loss of airspeed or altitude. If too much ice is allowed to accumulate, restoration of full power may not be possible; therefore, prompt action is required.

Turn carburetor heat on (See Note). RPM will decrease slightly and roughness will increase. Wait for a decrease in engine roughness or an increase in RPM, indicating ice removal. If no change in approximately one minute, return the carburetor heat to "OFF."

If the engine is still rough, adjust the mixture for maximum smoothness. The engine will run rough if too rich or too lean. The electric fuel pump should be switched to "ON" and the fuel selector switched to the other tank to see if fuel contamination is the problem. Check the engine gauges for abnormal readings. If any gauge readings are abnormal, proceed accordingly. Move the magneto switch to "L" then to "R," then back to "BOTH." If operation is satisfactory on either magneto, proceed on that magneto at reduced power, with mixture full "RICH," to a landing at the first available airport.

If roughness persists, prepare for a precautionary landing at pilot's discretion.

NOTE

Partial carburetor heat may be worse than no heat at all, since it may melt part of the ice, which will refreeze in the intake system. When using carburetor heat, therefore, always use full heat, and when ice is removed return the control to the full cold position.

THIS PAGE INTENTIONALLY LEFT BLANK

TABLE OF CONTENTS
SECTION 4
NORMAL PROCEDURES

Paragraph No.		Page No.
4.1	General	4-1
4.3	Airspeeds For Safe Operations	4-1
4.5	Normal Procedures Check List	4-3
	Preflight Check	4-3
	Before Starting Engine	4-4
	Starting Engine When Cold	4-4
	Starting Engine When Hot	4-4
	Starting Engine When Flooded	4-4
	Starting With External Power Source	4-4
	Warm-Up	4-4
	Taxiing	4-4
	Ground Check	4-4
	Before Takeoff	4-5
	Takeoff	4-5
	Climb	4-5
	Cruising	4-5
	Descent (Normal)	4-5
	Descent (Power OFF)	4-5
	Approach And Landing	4-6
	Stopping Engine	4-6
	Parking	4-6
4.7	Amplified Normal Procedures (General)	4-7
4.9	Preflight Check	4-7
4.11	Before Starting Engine	4-8
4.13	Starting Engine	4-9
4.15	Warm-Up	4-11
4.17	Taxiing	4-11
4.19	Ground Check	4-11
4.21	Before Takeoff	4-12
4.23	Takeoff	4-12
4.25	Climb	4-13
4.27	Cruising	4-13
4.28	Descent	4-13
4.29	Approach and Landing	4-14
4.31	Stopping Engine	4-15
4.33	Parking	4-15
4.35	Stalls	4-15
4.37	Turbulent Air Operation	4-16
4.39	Weight and Balance	4-16

SECTION 4 NORMAL PROCEDURES

4.1 GENERAL

This section clearly describes the recommended procedures for the conduct of normal operations for the Cherokee Archer II. All of the required (FAA regulations) procedures and those necessary for the safe operation of the airplane as determined by the operating and design features of the airplane are presented.

Normal procedures associated with those optional systems and equipment which require handbook supplements are provided by Section 9 (Supplements).

These procedures are provided to present a source of reference and review and to supply information on procedures which are not the same for all aircraft. Pilots should familiarize themselves with the procedures given in this section in order to become proficient in the normal operations of the airplane.

The first portion of this section consists of a short form check list which supplies an action sequence for normal operations with little emphasis on the operation of the systems.

The remainder of the section is devoted to amplified normal procedures which provide detailed information and explanations of the procedures and how to perform them. This portion of the section is not intended for use as an in-flight reference due to the lengthy explanations. The short form check list should be used for this purpose.

4.3 AIRSPEEDS FOR SAFE OPERATIONS

The following airspeeds are those which are significant to the safe operation of the airplane. These figures are for standard airplanes flown at gross weight under standard conditions at sea level.

Performance for a specific airplane may vary from published figures depending upon the equipment installed, the condition of the engine, airplane and equipment, atmospheric conditions and piloting technique.

(a) Best Rate of Climb Speed	76 KIAS
(b) Best Angle of Climb Speed	64 KIAS
(c) Turbulent Air Operating Speed (See Subsection 2.3)	113 KIAS
(d) Maximum Flap Speed	102 KIAS
(e) Landing Final Approach Speed (Flaps 40°)	66 KIAS
(f) Maximum Demonstrated Crosswind Velocity	17 KTS

THIS PAGE INTENTIONALLY LEFT BLANK

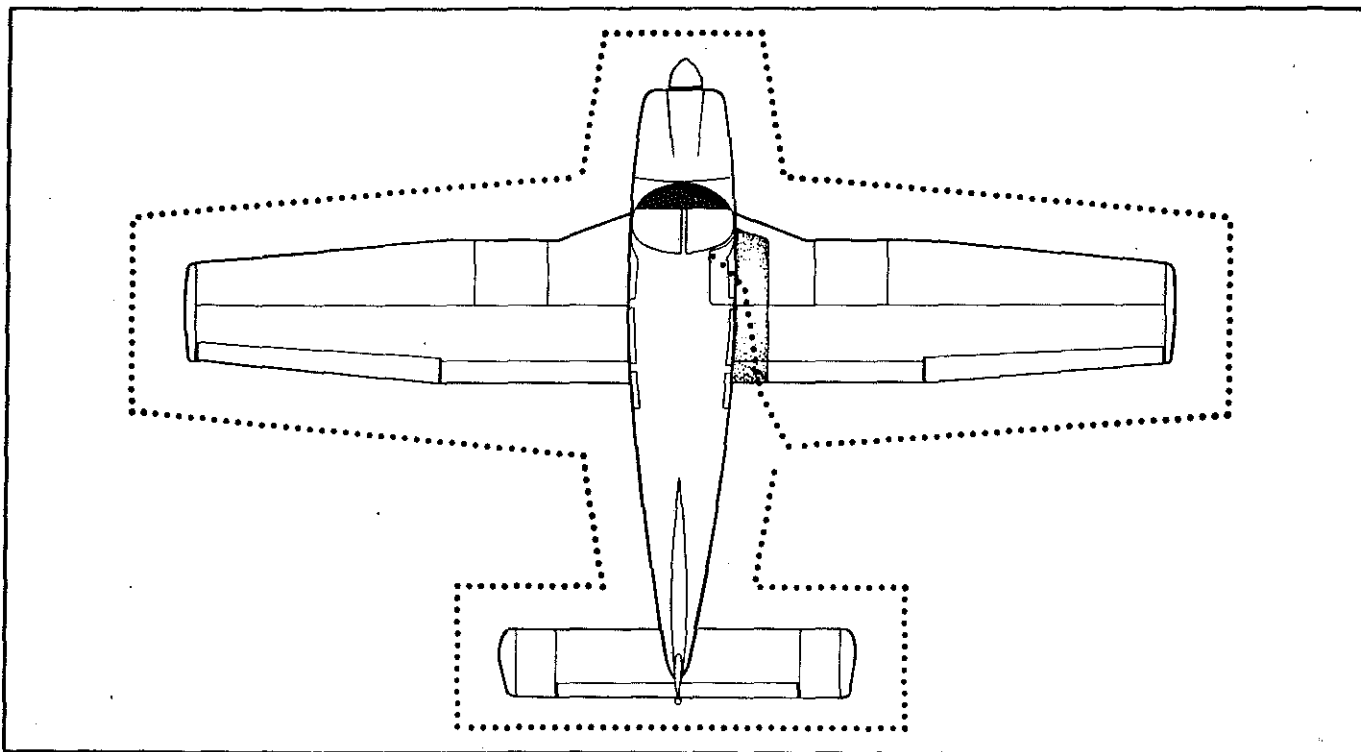

WALK-AROUND

Figure 4-1

4.5 NORMAL PROCEDURES CHECK LIST

PREFLIGHT

- | | | | |
|----------------------------|---|---------------------------------|---|
| Control wheel | release belts | Brake blocks | check |
| Master switch | ON | Pitot head | remove cover -
holes clear |
| Fuel quantity gauges | check | Windshield | clean |
| Master switch | OFF | Propeller and spinner | check |
| Ignition | OFF | Fuel and oil | check for leaks |
| Exterior | check for damage | Oil | check level |
| Control surfaces | check for interference -
free of ice, snow, frost | Dipstick | properly seated |
| Hinges | check for interference | Cowling | secure |
| Wings | free of ice, snow, frost | Inspection covers | secure |
| Stall warning | check | Nose wheel tire | check |
| Navigation lights | check | Nose gear strut | proper
inflation (3.25 in.) |
| Fuel tanks | check supply
visually - secure caps | Air inlets | clear |
| Fuel tank sumps | drain and check
for water, sediment
and proper fuel | Alternator belt | check tension |
| Fuel vents | open | Tow bar and control locks | stow |
| Main gear struts | proper
inflation (4.50 in.) | Baggage | stowed properly -
secure |
| Tires | check | Baggage door | close and secure |
| | | Fuel strainer | drain |
| | | Primary flight controls | proper operation |
| | | Cabin door | close and secure |
| | | Required papers | on board |
| | | Seat belts and harness | fastened/adjust -
check inertia reel |

APPROACH AND LANDING

Fuel selector proper tank
Seat backs erect
Belts/harness fasten/adjust
Electric fuel pump ON
Mixture set
Flaps set - 102 KIAS max
Air conditioner OFF
Trim to 75 KIAS
Final approach speed (flaps 40°) 66 KIAS

STOPPING ENGINE

Flaps retract
Electric fuel pump OFF
Air conditioner OFF
Radios OFF
Throttle full aft
Mixture idle cut-off
Magnetos OFF
Master switch OFF

PARKING

Parking brake set
Control wheel secured with belts
Flaps full up
Wheel chocks in place
Tie downs secure

4.7 AMPLIFIED NORMAL PROCEDURES (GENERAL)

The following paragraphs are provided to supply detailed information and explanations of the normal procedures necessary for the safe operation of the airplane.

4.9 PREFLIGHT CHECK

The airplane should be given a thorough preflight and walk-around check. The preflight should include a check of the airplane's operational status, computation of weight and C.G. limits, takeoff distance and in-flight performance. A weather briefing should be obtained for the intended flight path, and any other factors relating to a safe flight should be checked before takeoff.

CAUTION

The flap position should be noted before boarding the aircraft. The flaps must be placed in the "UP" position before they will lock and support weight on the step.

Upon entering the cockpit, release the seat belts securing the control wheel. Turn "ON" the master switch and check the fuel quantity gauges for sufficient fuel. After the fuel quantity check is made turn the master switch "OFF" and check that the ignition switch is "OFF."

To begin the exterior walk-around, check for external damage and operational interference of the control surfaces or hinges. Insure that the wings and control surfaces are free of snow, ice, frost or any other foreign materials.

An operational check of the stall warning system and navigation lights should now be made. Turn the master switch "ON." Lift the detector while checking to determine if the horn is actuated and check that the navigation lights are illuminated. The master switch should be returned to the "OFF" position after the checks are complete.

A visual check of the fuel tank quantity should be performed. Remove the filler cap from each tank and visually check the supply and color. Be sure to secure the caps properly after the check is complete.

The fuel system sumps and strainer should be drained daily prior to the first flight and after refueling to avoid the accumulation of contaminants such as water or sediment. Each fuel tank is equipped with an individual quick drain located at the lower inboard rear corner of the tank. The fuel strainer is equipped with a quick drain located on the front lower corner of the firewall. Each of the fuel tank sumps should be drained first. Then the fuel strainer should be drained twice, once with the fuel selector valve on each tank. Each time fuel is drained, sufficient fuel should be allowed to flow to ensure removal of contaminants. This fuel should be collected in a suitable container, examined for contaminants, and then discarded.

CAUTION

When draining any amount of fuel, care should be taken to ensure that no fire hazard exists before starting the engine.

Each quick drain should be checked after closing it to make sure it has closed completely and is not leaking.

Check all of the fuel tank vents to make sure they are open.

Next, complete a check of the landing gear. Check the main gear shock struts for proper inflation. There should be 4.50 inches of strut exposure under a normal static load. The nose gear should be checked for 3.25 inches of strut exposure. Check all tires for cuts and wear and insure proper inflation. Make a visual check of the brake blocks for wear or damage.

Remove the cover from the pitot head on the underside of the left wing. Check the pitot head to make sure the holes are open and clear of obstructions.

Don't forget to clean and check the windshield.

The propeller and spinner should be checked for defects or nicks.

Lift the cowling and check for any obvious fuel or oil leaks. Check the oil level. Make sure that the dipstick has properly seated after checking. Secure the cowling and check the inspection covers.

Check the air inlets for foreign matter and the alternator belt for proper tension.

Stow the tow bar and check the baggage for proper storage and security. The baggage compartment doors should be closed and secure.

Upon entering the aircraft, ascertain that all primary flight controls operate properly. Close and secure the cabin door and check that all the required papers are in order and in the airplane.

Fasten and adjust the seat belts and shoulder harness and check the function of the inertia reel by pulling sharply on the strap. Fasten seat belts on empty seats.

NOTE

If the fixed shoulder harness (non-inertia reel type) is installed, it must be connected to the seat belt and adjusted to allow proper accessibility to all controls, including fuel selector, flaps, trim, etc., while maintaining adequate restraint for the occupant.

If the inertia reel type shoulder harness is installed, a pull test of its locking restraint feature should be performed.

4.11 BEFORE STARTING ENGINE

Before starting the engine the brakes should be set "ON" and the carburetor heat lever moved to the full COLD position. The fuel selector should then be moved to the desired tank.

4.13 STARTING ENGINE

(a) Starting Engine When Cold

Open the throttle lever approximately 1/4 inch. Turn "ON" the master switch and the electric fuel pump.

Move the mixture control to full "RICH" and engage the starter by rotating the magneto switch clockwise and pressing in. When the engine fires, release the magneto switch, and move the throttle to the desired setting.

If the engine does not fire within five to ten seconds, disengage the starter, prime the engine and repeat the starting procedure.

(b) Starting Engine When Hot

Open the throttle approximately 1/2 inch. Turn "ON" the master switch and the electric fuel pump. Move the mixture control lever to full RICH and engage the starter by rotating the magneto switch clockwise and pressing in. When the engine fires, release the magneto switch and move the throttle to the desired setting.

(c) Starting Engine When Flooded

The throttle lever should be full "OPEN." Turn "ON" the master switch and turn "OFF" the electric fuel pump. Move the mixture control lever to idle cut-off and engage the starter by rotating the magneto switch clockwise and pressing in. When the engine fires, release the magneto switch, advance the mixture and retard the throttle.

(d) Starting Engine With External Power Source

An optional feature called the Piper External Power (PEP) allows the operator to use an external battery to crank the engine without having to gain access to the airplane's battery.

Turn the master switch OFF and turn all electrical equipment OFF. Connect the RED lead of the PEP kit jumper cable to the POSITIVE (+) terminal of an external 12-volt battery and the BLACK lead to the NEGATIVE (-) terminal. Insert the plug of the jumper cable into the socket located on the fuselage. Note that when the plug is inserted, the electrical system is ON. Proceed with the normal starting technique.

After the engine has started, reduce power to the lowest possible RPM, to reduce sparking, and disconnect the jumper cable from the aircraft. Turn the master switch ON and check the alternator ammeter for an indication of output. **DO NOT ATTEMPT FLIGHT IF THERE IS NO INDICATION OF ALTERNATOR OUTPUT.**

NOTE

For all normal operations using the PEP jumper cables, the master switch should be OFF, but it is possible to use the ship's battery in parallel by turning the master switch ON. This will give longer cranking capabilities, but will not increase the amperage.

CAUTION

Care should be exercised because if the ship's battery has been depleted, the external power supply can be reduced to the level of the ship's battery. This can be tested by turning the master switch ON momentarily while the starter is engaged. If cranking speed increases, the ship's battery is at a higher level than the external power supply.

4.15 WARM-UP

Warm-up the engine at 800 to 1200 RPM for not more than two minutes in warm weather and four minutes in cold. Avoid prolonged idling at low RPM, as this practice may result in fouled spark plugs.

Takeoff may be made as soon as the ground check is completed, provided that the throttle may be opened fully without backfiring or skipping, and without a reduction in engine oil pressure.

Do not operate the engine at high RPM when running up or taxiing over ground containing loose stones, gravel or any loose material that may cause damage to the propeller blades.

4.17 TAXIING

Before attempting to taxi the airplane, ground personnel should be instructed and approved by a qualified person authorized by the owner. Ascertain that the propeller back blast and taxi areas are clear.

Power should be applied slowly to start the taxi roll. Taxi a few feet forward and apply the brakes to determine their effectiveness. While taxiing, make slight turns to ascertain the effectiveness of the steering.

Observe wing clearances when taxiing near buildings or other stationary objects. If possible, station an observer outside the airplane.

Avoid holes and ruts when taxiing over uneven ground.

Do not operate the engine at high RPM when running up or taxiing over ground containing loose stones, gravel or any loose material that may cause damage to the propeller blades.

4.19 GROUND CHECK

The magnetos should be checked at 2000 RPM. Drop off on either magneto should not exceed 175 RPM and the difference between the magnetos should not exceed 50 RPM. Operation on one magneto should not exceed 10 seconds.

Check the vacuum gauge; the indicator should read 5.0" \pm .1" Hg at 2000 RPM.

Check the annunciator panel lights with the press-to-test button. Also check the air conditioner.

Carburetor heat should also be checked prior to takeoff to be sure the control is operating properly and to clear any ice which may have formed during taxiing. Avoid prolonged ground operation with carburetor heat "ON" as the air is unfiltered.

The electric fuel pump should be turned "OFF" after starting or during warm-up to make sure that the engine driven pump is operating. Prior to takeoff the electric pump should be turned ON again to prevent loss of power during takeoff should the engine driven pump fail. Check both oil temperature and oil pressure. The temperature may be low for some time if the engine is being run for the first time of the day. The engine is warm enough for takeoff when the throttle can be opened without the engine faltering.

4.21 BEFORE TAKEOFF

All aspects of each particular takeoff should be considered prior to executing the takeoff procedure.

Turn "ON" the master switch and check and set all of the flight instruments as required. Check the fuel selector to make sure it is on the proper tank (fullest). Turn "ON" the electric fuel pump and check the engine gauges. The carburetor heat should be in the "OFF" position.

All seat backs should be erect.

The mixture should be set and the primer checked to insure that it is locked. The seat belts and shoulder harness should be fastened and adjusted. Fasten the seat belts snugly around the empty seats.

NOTE

If the fixed shoulder harness (non-inertia reel type) is installed, it must be connected to the seat belt and adjusted to allow proper accessibility to all controls, including fuel selector, flaps, trim, etc., while maintaining adequate restraint for the occupant.

If the inertia reel type shoulder harness is installed, a pull test of its locking restraint feature should be performed.

Exercise and set the flaps and trim tab. Insure proper flight control movement and response.

All doors should be properly secured and latched.

On air conditioned models, the air conditioner must be "OFF" to insure normal takeoff performance.

4.23 TAKEOFF

The normal takeoff technique is conventional for the Cherokee Archer II. The tab should be set slightly aft of neutral, with the exact setting determined by the loading of the airplane. Allow the airplane to accelerate to 48 to 53 KIAS depending on the weight of the aircraft and ease back on the control wheel to rotate to climb attitude.

The procedure used for a short field takeoff with an obstacle clearance or a soft field takeoff differs slightly from the normal technique. The flaps should be lowered to 25° (second notch). Allow the aircraft to accelerate to 41 to 49 KIAS depending on the aircraft weight and rotate the aircraft to climb attitude. After breaking ground, accelerate to 45 to 54 KIAS, depending on aircraft weight. Continue to climb while accelerating to the flaps-up rate of climb speed, 76 KIAS if no obstacle is present or 64 KIAS if obstacle clearance is a consideration. Slowly retract the flaps while climbing out.

4.25 CLIMB

The best rate of climb at gross weight will be obtained at 76 KIAS. The best angle of climb may be obtained at 64 KIAS. At lighter than gross weight these speeds are reduced somewhat. For climbing en route, a speed of 87 KIAS is recommended. This will produce better forward speed and increased visibility over the nose during the climb.

When reaching the desired altitude, the electric fuel pump may be turned off.

4.27 CRUISING

The cruising speed of the Cherokee Archer II is determined by many factors, including power setting, altitude, temperature, loading and equipment installed in the airplane.

The normal maximum cruising power is 75% of the rated horsepower of the engine. Airspeeds which may be obtained at various altitudes and power settings can be determined from the performance graphs provided by Section 5.

Use of the mixture control in cruising flight reduces fuel consumption significantly, especially at higher altitudes. The mixture should be leaned during cruising operation above 5000 ft. altitude and at pilot's discretion at lower altitudes when 75% power or less is being used. If any doubt exists as to the amount of power being used, the mixture should be in the full "RICH" position for all operations under 5000 feet.

To lean the mixture, disengage the lock and pull the mixture control until the engine becomes rough, indicating that the lean mixture limit has been reached in the leaner cylinders. Then enrich the mixture by pushing the control towards the instrument panel until engine operation becomes smooth.

If the airplane is equipped with the optional exhaust gas temperature (EGT) gauge, a more accurate means of leaning is available to the pilot. For this procedure, refer to the "Avco-Lycoming Operator's Manual."

Always remember that the electric fuel pump should be turned "ON" before switching tanks, and should be left on for a short period thereafter. In order to keep the airplane in best lateral trim during cruising flight, the fuel should be used alternately from each tank. It is recommended that one tank be used for one hour after takeoff, then the other tank be used for two hours; then return to the first tank, which will have approximately one and one half hours of fuel remaining if the tanks were full at takeoff. The second tank will contain approximately one half hour of fuel. Do not run tanks completely dry in flight. The electric fuel pump should be normally "OFF" so that any malfunction of the engine driven fuel pump is immediately apparent. If signs of fuel starvation should occur at any time during flight, fuel exhaustion should be suspected, at which time the fuel selector should be immediately positioned to the other tank and the electric fuel pump switched to the "ON" position.

4.28 DESCENT

NORMAL

To achieve the performance on Figure 5-29 the power on descent must be used. The throttle should be set for 2500 RPM, mixture full rich and maintain an airspeed of 122 KIAS. In case carburetor ice is encountered apply full carburetor heat.

POWER OFF

If a prolonged power off descent is to be made, apply full carburetor heat prior to power reduction if icing conditions are suspected. Throttle should be retarded and mixture control leaned as required. Power response should be verified approximately every 30 seconds by partially opening and then closing the throttle (clearing the engine). When leveling off enrichen mixture, set power as required and select carburetor heat off unless carburetor icing conditions are suspected.

4.29 APPROACH AND LANDING

Check to insure the fuel selector is on the proper (fullest) tank and that the seat backs are erect. The seat belts and shoulder harness should be fastened and adjusted and the inertia reel checked.

NOTE

If the fixed shoulder harness (non-inertia reel type) is installed, it must be connected to the seat belt and adjusted to allow proper accessibility to all controls, including fuel selector, flaps, trim, etc., while maintaining adequate restraint for the occupant.

If the inertia reel type shoulder harness is installed, a pull test of its locking restraint feature should be performed.

Turn "ON" the electric fuel pump and turn "OFF" the air conditioner. The mixture should be set in the full "RICH" position.

The airplane should be trimmed to an initial approach speed of about 75 KIAS with a final approach speed of 66 KIAS with flaps extended. The flaps can be lowered at speeds up to 102 KIAS, if desired.

The mixture control should be kept in full "RICH" position to insure maximum acceleration if it should be necessary to open the throttle again. Carburetor heat should not be applied unless there is an indication of carburetor icing, since the use of carburetor heat causes a reduction in power which may be critical in case of a go-around. Full throttle operation with carburetor heat on can cause detonation.

The amount of flap used during landings and the speed of the aircraft at contact with the runway should be varied according to the landing surface and conditions of wind and airplane loading. It is generally good practice to contact the ground at the minimum possible safe speed consistent with existing conditions.

Normally, the best technique for short and slow landings is to use full flap and enough power to maintain the desired airspeed and approach flight path. Mixture should be full "RICH," fuel on the fullest tank, and electric fuel pump "ON." Reduce the speed during the flareout and contact the ground close to the stalling speed. After ground contact hold the nose wheel off as long as possible. As the airplane slows down, gently lower the nose and apply the brakes. Braking is most effective when flaps are raised and back pressure is applied to the control wheel, putting most of the aircraft weight on the main wheels. In high wind conditions, particularly in strong crosswinds, it may be desirable to approach the ground at higher than normal speeds with partial or no flaps.

4.31 STOPPING ENGINE

At the pilot's discretion, the flaps should be raised and the electric fuel pump turned "OFF."

NOTE

The flaps must be placed in the "UP" position for the flap step to support weight. Passengers should be cautioned accordingly.

The air conditioner and radios should be turned "OFF," and the engine stopped by disengaging the mixture control lock and pulling the mixture control back to idle cut-off. The throttle should be left full aft to avoid engine vibration while stopping. Then the magneto and master switches must be turned "OFF."

4.33 PARKING

If necessary, the airplane should be moved on the ground with the aid of the nose wheel tow bar provided with each airplane and secured behind the rear seats. The aileron and stabilator controls should be secured by looping the safety belt through the control wheel and pulling it snug. The flaps are locked when in the "UP" position and should be left retracted.

Tie downs can be secured to rings provided under each wing and to the tail skid. The rudder is held in position by its connections to the nose wheel steering and normally does not have to be secured.

4.35 STALLS

The stall characteristics of the Cherokee Archer II are conventional. An approaching stall is indicated by a stall warning horn which is activated between five and ten miles per hour above stall speed. Mild airframe buffeting and gentle pitching may also precede the stall.

The gross weight stalling speed of the Cherokee Archer II with power off and full flaps is 49 KIAS. With the flaps up this speed is increased 6 KTS. Loss of altitude during stalls varies from 100 to 350 feet, depending on configuration and power.

NOTE

The stall warning system is inoperative with the master switch "OFF."

During preflight, the stall warning system should be checked by turning the master switch "ON," lifting the detector and checking to determine if the horn is actuated. The master switch should be returned to the "OFF" position after the check is complete.

4.37 TURBULENT AIR OPERATION

In keeping with good operating practice used in all aircraft, it is recommended that when turbulent air is encountered or expected, the airspeed be reduced to maneuvering speed to reduce the structural loads caused by gusts and to allow for inadvertent speed build-ups which may occur as a result of the turbulence or of distractions caused by the conditions. (See Subsection 2.3)

4.39 WEIGHT AND BALANCE

It is the responsibility of the owner and pilot to determine that the airplane remains within the allowable weight vs. center of gravity envelope while in flight.

For weight and balance data, refer to Section 6 (Weight and Balance).

TABLE OF CONTENTS

SECTION 5

PERFORMANCE

Paragraph No.		Page No.
5.1	General	5-1
5.3	Introduction to Performance and Flight Planning	5-1
5.5	Flight Planning Example	5-3
5.7	Performance Graphs	5-9
	List of Figures	5-9

SECTION 5
PERFORMANCE

5.1 GENERAL

All of the required (FAA regulations) and complementary performance information applicable to the Cherokee Archer II is provided by this section.

Performance information associated with those optional systems and equipment which require handbook supplements is provided by Section 9 (Supplements).

5.3 INTRODUCTION TO PERFORMANCE AND FLIGHT PLANNING

The performance information presented in this section is based on measured Flight Test Data corrected to I.C.A.O. standard day conditions and analytically expanded for the various parameters of weight, altitude, temperature, etc.

The performance charts are unfactored and do not make any allowance for varying degrees of pilot proficiency or mechanical deterioration of the aircraft. This performance, however, can be duplicated by following the stated procedures in a properly maintained airplane.

Effects of conditions not considered on the charts must be evaluated by the pilot, such as the effect of soft or grass runway surface on takeoff and landing performance, or the effect of winds aloft on cruise and range performance. Endurance can be grossly affected by improper leaning procedures, and inflight fuel flow and quantity checks are recommended.

REMEMBER! To get chart performance, follow the chart procedures.

The information provided by paragraph 5.5 (Flight Planning Example) outlines a detailed flight plan using the performance charts in this section. Each chart includes its own example to show how it is used.

THIS PAGE INTENTIONALLY LEFT BLANK

5.5 FLIGHT PLANNING EXAMPLE

(a) Aircraft Loading

The first step in planning our flight is to calculate the airplane weight and center of gravity by utilizing the information provided by Section 6 (Weight and Balance) of this handbook.

The basic empty weight for the airplane as delivered from the factory has been entered in Figure 6-5. If any alterations to the airplane have been made effecting weight and balance, reference to the aircraft logbook and Weight and Balance Record (Figure 6-7) should be made to determine the current basic empty weight of the airplane.

Make use of the Weight and Balance Loading Form (Figure 6-11) and the C.G. Range and Weight graph (Figure 6-15) to determine the total weight of the airplane and the center of gravity position.

After proper utilization of the information provided we have found the following weights for consideration in our flight planning example.

The landing weight cannot be determined until the weight of the fuel to be used has been established [refer to item (g)(1)].

(1) Basic Empty Weight	1400 lbs.
(2) Occupants (2 x 170 lbs)	340 lbs.
(3) Baggage and Cargo	360 lbs.
(4) Fuel (6 lb/gal x 50)	300 lbs.
(5) Takeoff Weight	2400 lbs.
(6) Landing Weight	
(a)(5) minus (g)(1), (2400 lbs. minus 136 lbs.)	2264 lbs.

Our takeoff weight is below the maximum of 2550 lbs. and our weight and balance calculations have determined our C.G. position within the approved limits.

(b) Takeoff and Landing

Now that we have determined our aircraft loading, we must consider all aspects of our takeoff and landing.

All of the existing conditions at the departure and destination airport must be acquired, evaluated and maintained throughout the flight.

Apply the departure airport conditions and takeoff weight to the appropriate Takeoff Performance graph (Figure 5-5 or 5-7) to determine the length of runway necessary for the takeoff and/or the barrier distance.

The landing distance calculations are performed in the same manner using the existing conditions at the destination airport and, when established, the landing weight.

The conditions and calculations for our example flight are listed below. The takeoff and landing distances required for our example flight have fallen well below the available runway lengths.

	Departure Airport	Destination Airport
(1) Pressure Altitude	2000 ft.	2300 ft.
(2) Temperature	70°F	70°F
(3) Wind Component	10 KTS	5 KTS
(4) Runway Length Available	7000 ft.	4500 ft.
(5) Runway Required	950 ft.*	825**

NOTE

The remainder of the performance charts used in this flight plan example assume a no wind condition. The effect of winds aloft must be considered by the pilot when computing climb, cruise and descent performance.

(c) Climb

The next step in our flight plan is to determine the necessary climb segment components.

The desired cruise pressure altitude and corresponding cruise outside air temperature values are the first variables to be considered in determining the climb components from the Time, Distance, and Fuel to Climb graph (Figure 5-15). After the time, distance and fuel for the cruise pressure altitude and outside air temperature values have been established, apply the existing conditions at the departure field to the graph (Figure 5-15). Now, subtract the values obtained from the graph for the field of departure conditions from those for the cruise pressure altitude.

The remaining values are the true fuel, distance and time components for the climb segment of the flight plan corrected for field pressure altitude and temperature.

The following values were determined from the above instructions in our flight planning example.

(1) Cruise Pressure Altitude	6000 ft.
(2) Cruise OAT	55°F
(3) Time to Climb (12.5 min. minus 4.5 min.)	8 min.***
(4) Distance to Climb (17.5 minus 6.5 nautical miles)	11 nautical miles***
(5) Fuel to Climb (3 gal. minus 1 gal.)	2 gal.***

*reference Figure 5-11

**reference Figure 5-35

***reference Figure 5-15

(d) Descent

The descent data will be determined prior to the cruise data to provide the descent distance for establishing the total cruise distance.

Utilizing the cruise pressure altitude and OAT we determine the basic time, distance and fuel for descent (Figure 5-29). These figures must be adjusted for the field pressure altitude and temperature at the destination airport. To find the necessary adjustment values, use the existing pressure altitude and temperature conditions at the destination airport as variables to find the time, distance and fuel values from the graph (Figure 5-29). Now, subtract the values obtained from the field conditions from the values obtained from the cruise conditions to find the true time, distance and fuel values needed for the flight plan.

The values obtained by proper utilization of the graphs for the descent segment of our example are shown below.

(1) Time to Descend (17 min. minus 10.5 min.)	6.5 min.*
(2) Distance to Descend (35 minus 22 nautical miles)	13 nautical miles*
(3) Fuel to Descend (1.7 gal. minus 1 gal.)	.7 gal.*

(e) Cruise

Using the total distance to be traveled during the flight, subtract the previously calculated distance to climb and distance to descend to establish the total cruise distance. Refer to the appropriate Avco Lycoming Operator's Manual when selecting the cruise power setting. The established pressure altitude and temperature values and the selected cruise power should now be utilized to determine the true airspeed from the appropriate Speed Power graph (Figure 5-19 or 5-21).

Calculate the cruise fuel flow for the cruise power setting from the information provided by the Avco Lycoming Operator's Manual.

The cruise time is found by dividing the cruise distance by the cruise speed and the cruise fuel is found by multiplying the cruise fuel flow by the cruise time.

The cruise calculations established for the cruise segment of our flight planning example are as follows:

(1) Total Distance	314 nautical miles
(2) Cruise Distance	
(e)(1) minus (c)(4) minus (d)(2), (314 minus 11 minus 13)	290 nautical miles
(3) Cruise Power	65% rated power
(4) Cruise Speed	110 KTS TAS**
(5) Cruise Fuel	7.6 GPH
(6) Cruise Time	
(e)(2) divided by (e)(4), (290 nautical miles divided by 110 KTS)	2.64 hrs.
(7) Cruise Fuel	
(e)(5) multiplied by (e)(6), (7.6 GPH multiplied by 2.64 hrs.)	20 gal.

*reference Figure 5-29

**reference Figure 5-21

(f) Total Flight Time

The total flight time is determined by adding the time to climb, the time to descend and the cruise time. Remember! The time values taken from the climb and descent graphs are in minutes and must be converted to hours before adding them to the cruise time.

The following flight time is required for our flight planning example.

- (1) Total Flight Time
(c)(3) plus (d)(1) plus (e)(6), (.13 hrs. plus .11 hrs. plus 2.64 hrs.) 2.88 hrs.

(g) Total Fuel Required

Determine the total fuel required by adding the fuel to climb, the fuel to descend and the cruise fuel. When the total fuel (in gallons) is determined, multiply this value by 6 lb/gal to determine the total fuel weight used for the flight.

The total fuel calculations for our example flight plan are shown below.

- (1) Total Fuel Required
(c)(5) plus (d)(3) plus (e)(7), (2 gal. plus .7 gal. plus 20 gal.) 22.7 gal.
(22.7 gal. multiplied by 6 lb/gal.) 136 lbs.

5.7 PERFORMANCE GRAPHS

LIST OF FIGURES

Figure No.		Page No.
5-1	Airspeed System Calibration	5-11
5-3	Stall Speeds	5-12
5-5	Flaps Up Takeoff Performance	5-13
5-7	25° Flaps Takeoff Performance	5-14
5-9	Flaps Up Takeoff Ground Roll	5-15
5-11	25° Flaps Takeoff Ground Roll	5-16
5-13	Climb Performance	5-17
5-15	Time, Distance and Fuel to Climb	5-18
5-17	Engine Performance (Serial Nos. 28-7790001 through 7790607)	5-19
5-18	Engine Performance (Serial Nos. 28-7890001 and up)	5-20
5-19	Speed Power - Performance Cruise (Serial Nos. 28-7790001 through 7790607)	5-21
5-20	Speed Power - Performance Cruise (Serial Nos. 28-7890001 and up)	5-22
5-21	Speed Power - Economy Cruise (Serial Nos. 28-7790001 through 7790607)	5-23
5-22	Speed Power - Economy Cruise (Serial Nos. 28-7890001 and up)	5-24
5-23	Best Power Mixture Range (Serial Nos. 28-7790001 through 7790607)	5-25
5-24	Best Power Mixture Range (Serial Nos. 28-7890001 and up)	5-26
5-25	Best Economy Mixture Range (Serial Nos. 28-7790001 through 7790607)	5-27
5-26	Best Economy Mixture Range (Serial Nos. 28-7890001 and up)	5-28
5-27	Endurance	5-29
5-29	Time, Distance and Fuel to Descend	5-30
5-31	Glide Range	5-31
5-33	Landing Performance	5-32
5-35	Landing Ground Roll	5-33

THIS PAGE INTENTIONALLY LEFT BLANK

PA-28-181

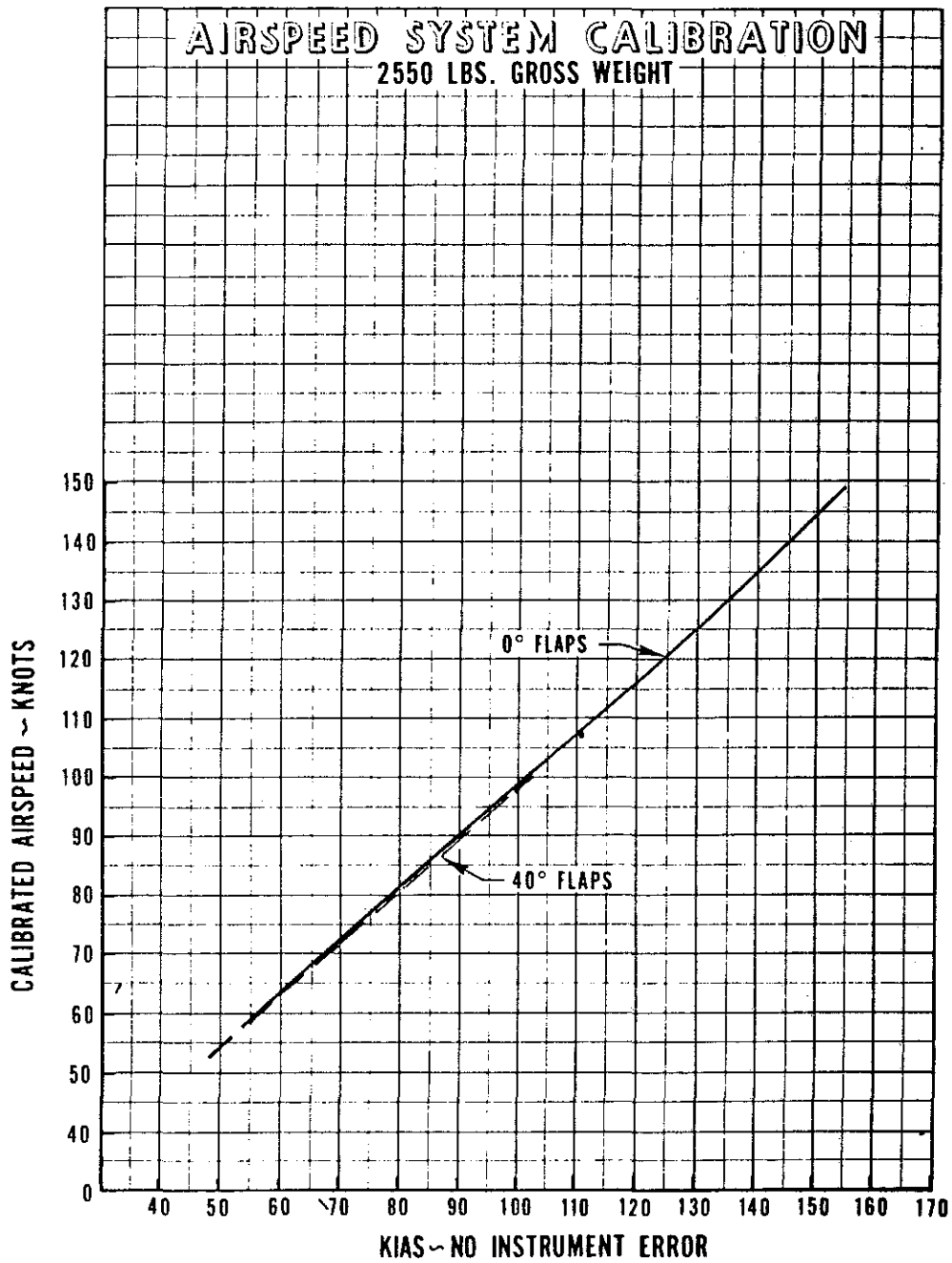

AIRSPEED SYSTEM CALIBRATION

Figure 5-1

PA-28-181

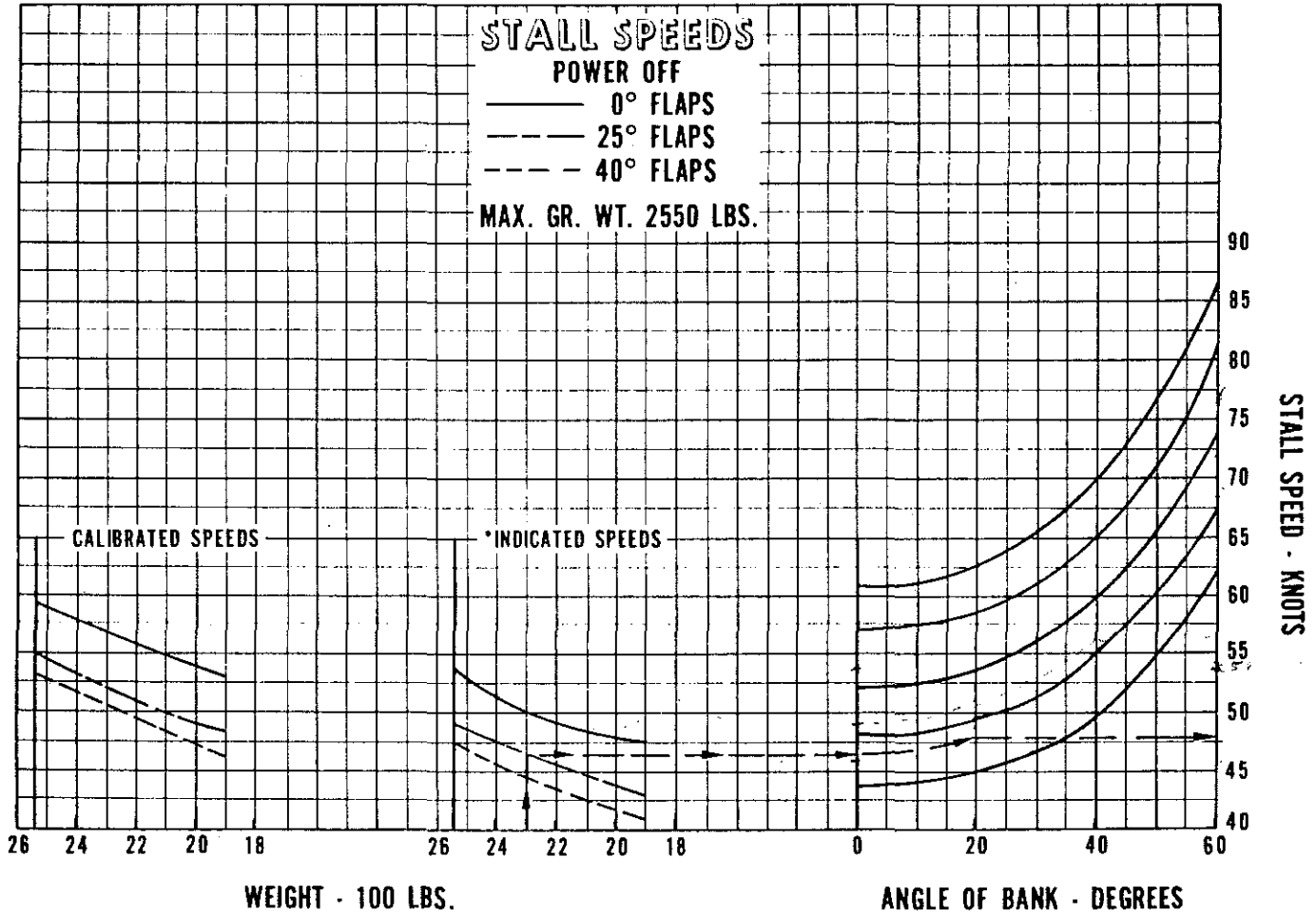

Example:

Gross weight: 2300 lbs.
 Angle of bank: 20°
 Flap position: 25°
 Stall speed: 46 knots (*indicated airspeed)

*INDICATED AIRSPEED, NO INDICATOR ERROR

STALL SPEEDS

Figure 5-3

PA-28-181

PIPER AIRCRAFT CORPORATION
PA-28-181, CHEROKEE ARCHER II

SECTION 5
PERFORMANCE

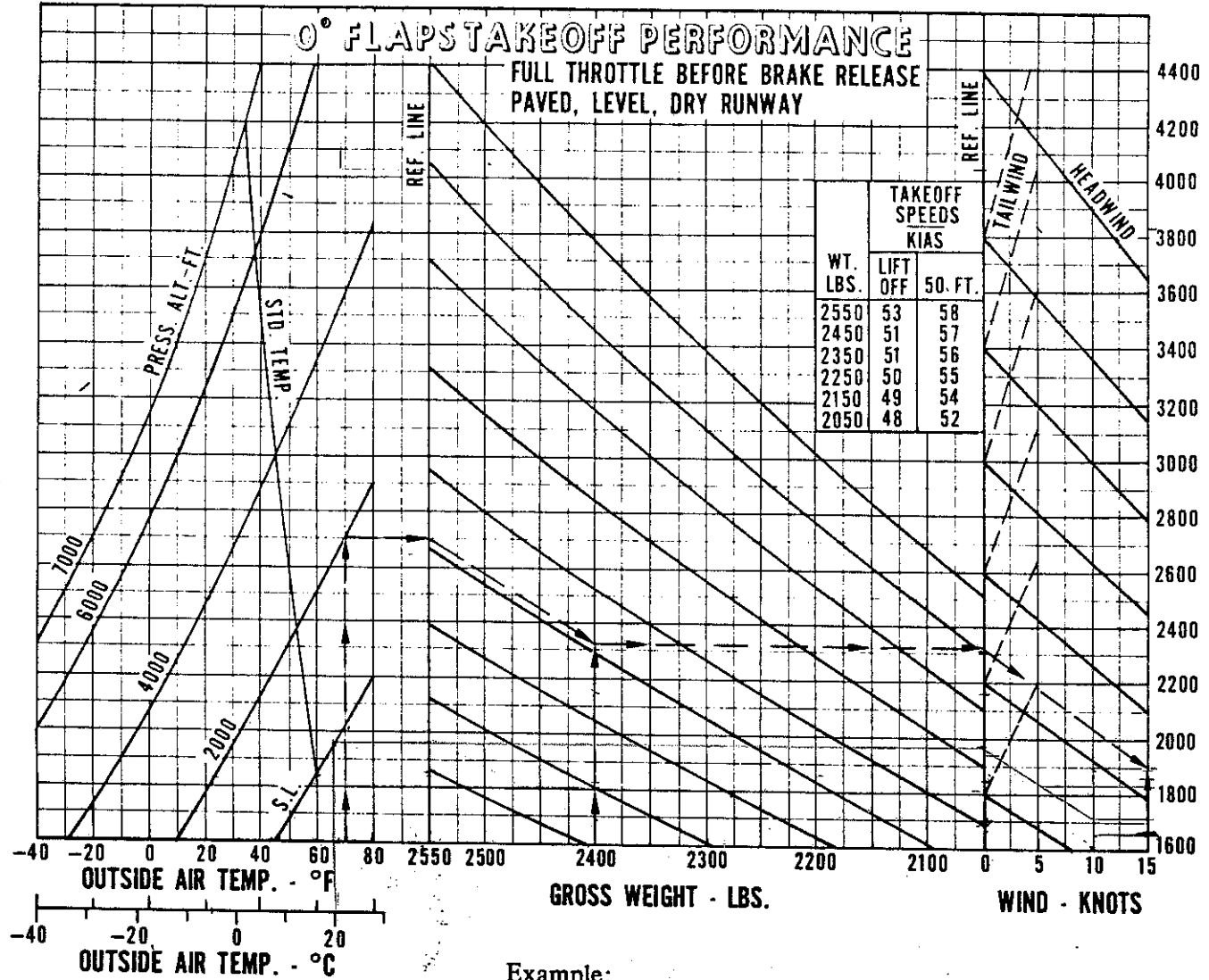

Example:

Departure airport pressure altitude: 2000 ft.

Temperature: 70°F

Wind: 15 KT. (headwind)

Gross weight: 2400 lbs.

Takeoff distance: 1900 ft.

FLAPS UP TAKEOFF PERFORMANCE

Figure 5-5

ISSUED: JUNE 18, 1976

REPORT: VB-790
5-13

PA-28-181

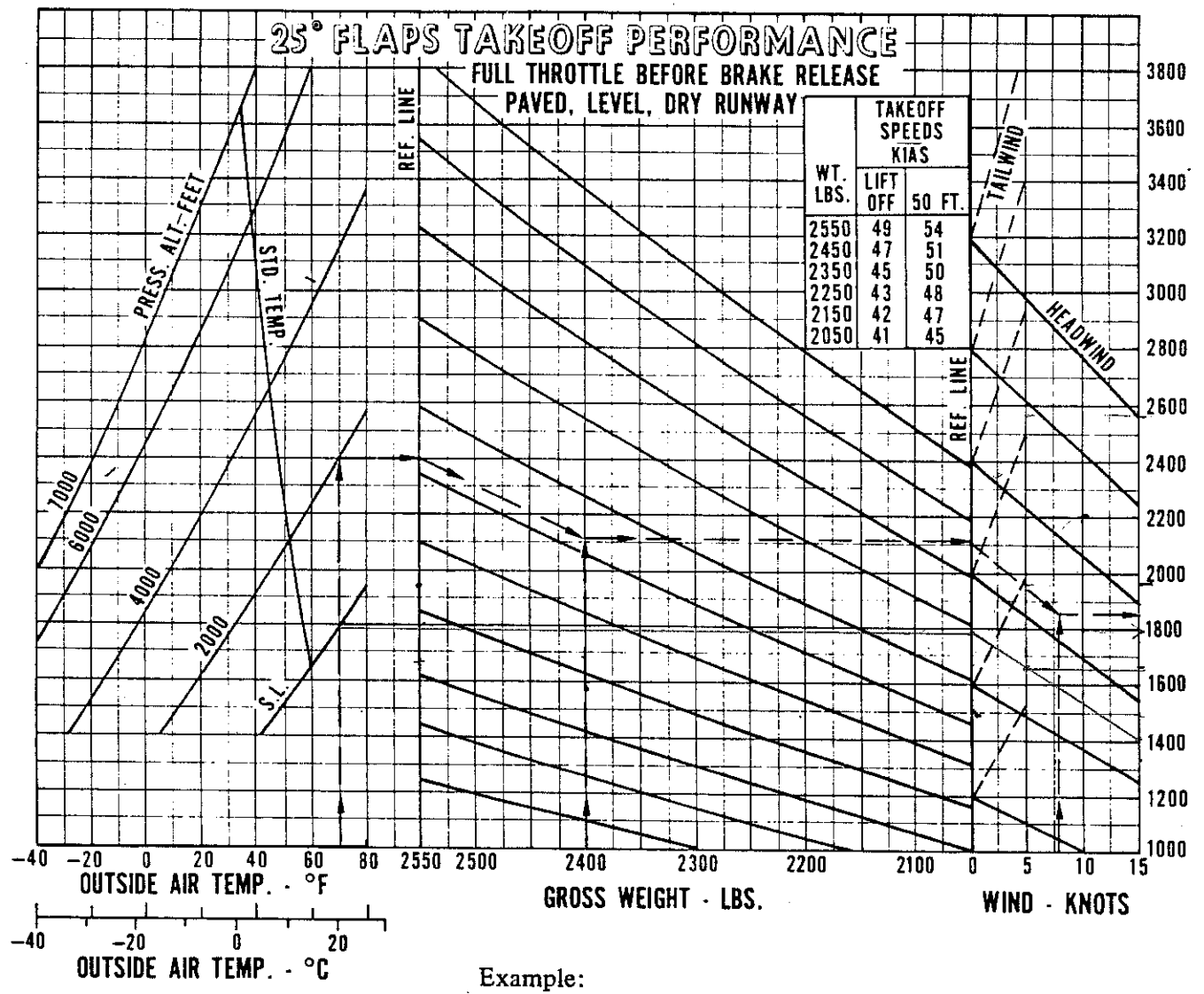

Example:
 Departure airport pressure altitude: 2000 ft.
 Temperature: 70°F
 Gross weight: 2400 lbs.
 Wind: 8 knots (headwind)
 Takeoff distance: 1860 ft.

25° FLAPS TAKEOFF PERFORMANCE
Figure 5-7

PA-28-181

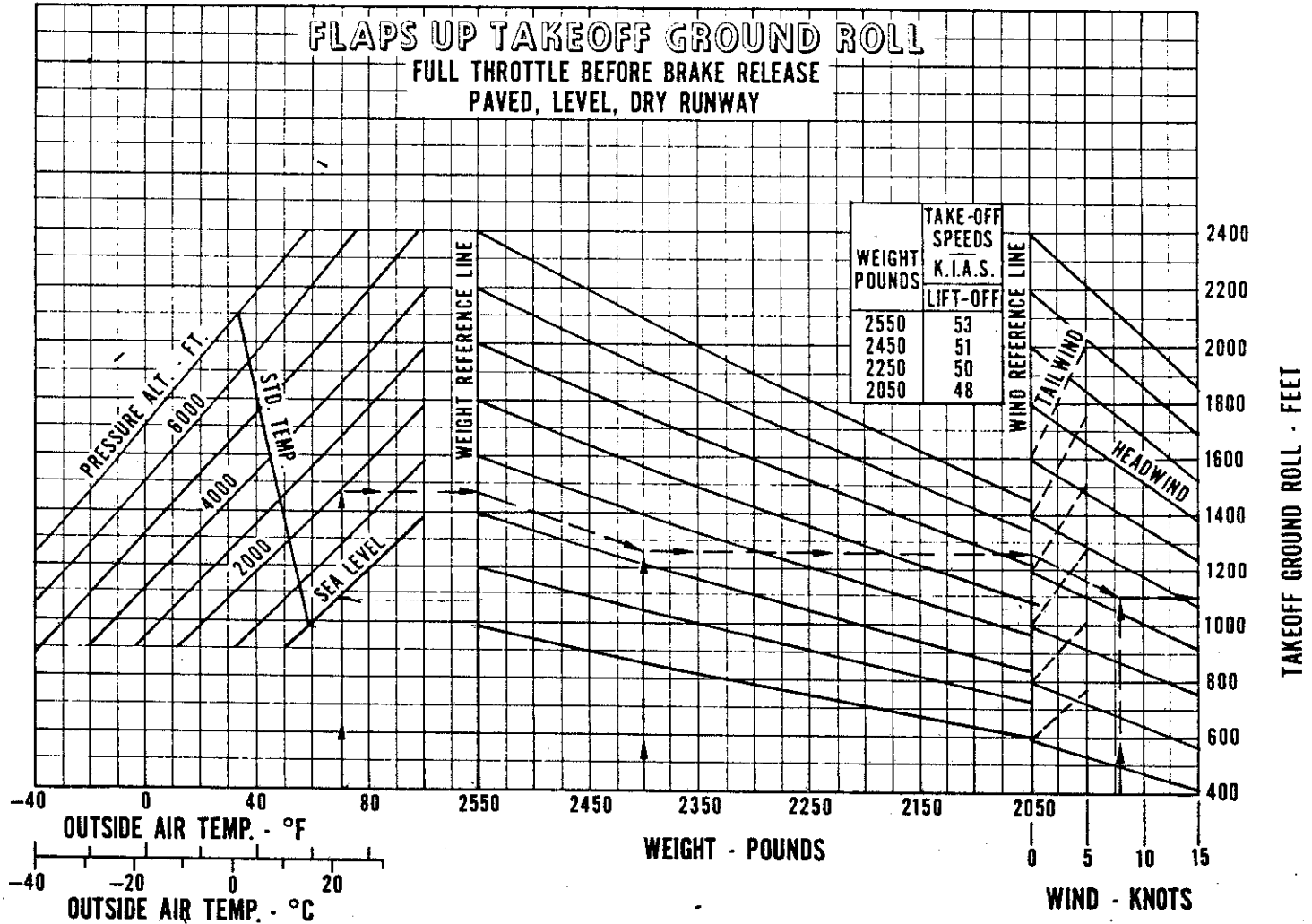

Example:
 Departure airport pressure altitude: 2000 ft.
 Temperature: 70°F
 Gross weight: 2400 lbs.
 Wind: 8 knots (headwind)
 Takeoff ground roll: 1100 ft.

FLAPS UP TAKEOFF GROUND ROLL

Figure 5-9

PA-28-181

25° FLAPS TAKEOFF GROUND ROLL
FULL THROTTLE BEFORE BRAKE RELEASE
PAVED, LEVEL, DRY RUNWAY

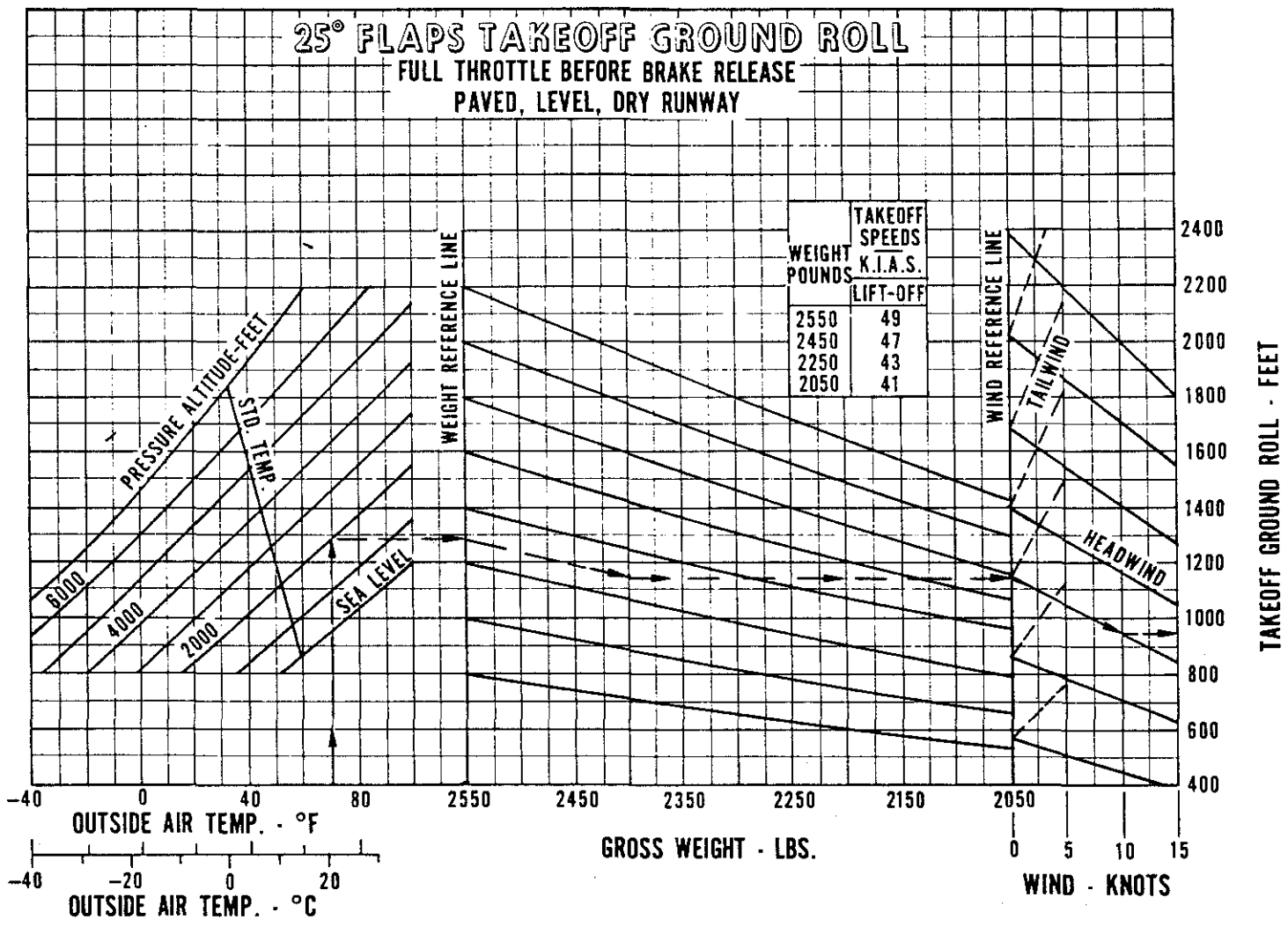

Example:
 Departure airport pressure altitude: 2000 ft.
 Temperature: 70°F
 Gross weight: 2400 lbs.
 Wind: 10 knots (headwind)
 Takeoff ground roll: 950 ft.

25° FLAPS TAKEOFF GROUND ROLL
Figure 5-11

PA-28-181

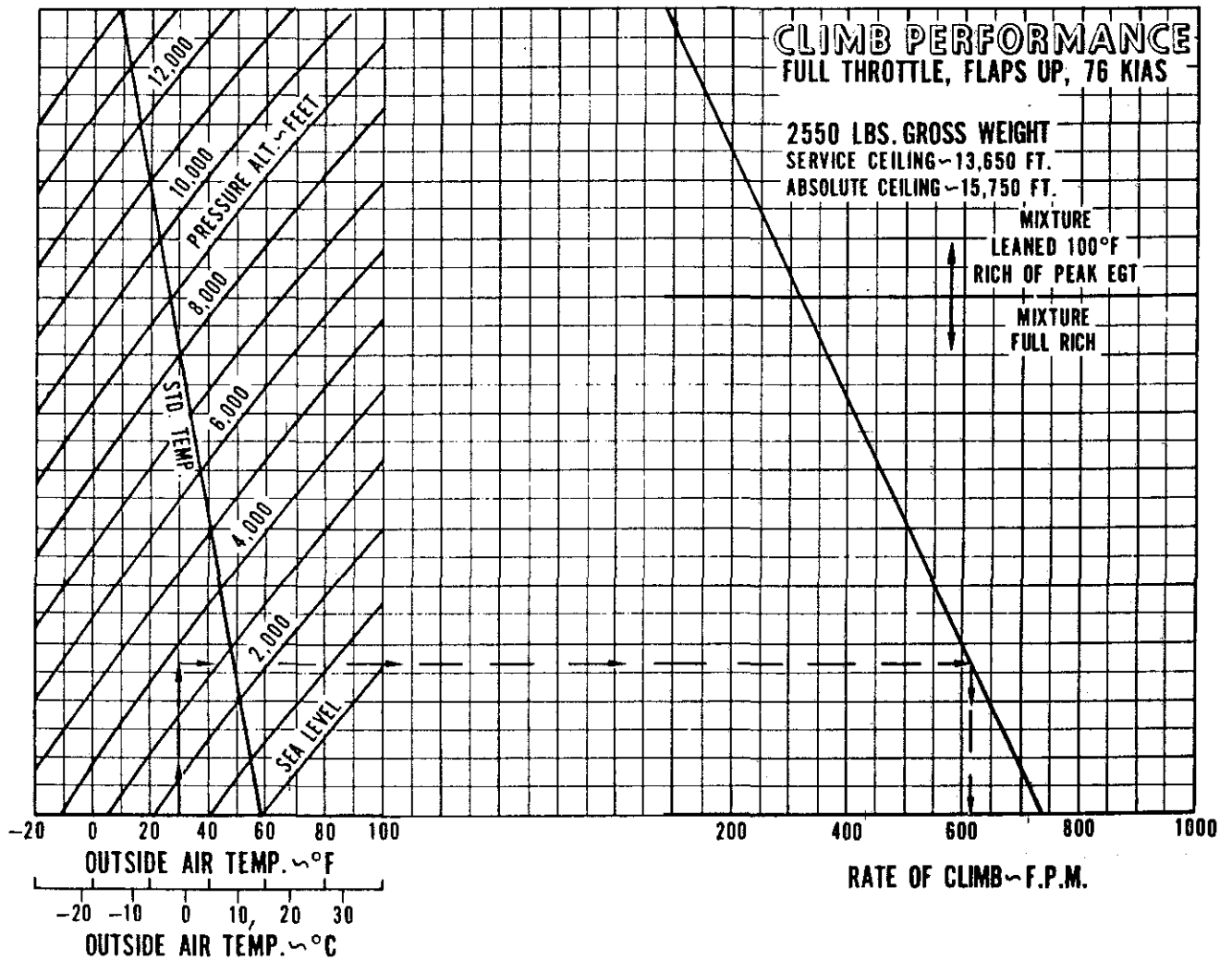

Example:

Climb pressure altitude: 3600 ft.

OAT: 30°F

Rate of climb: 620 F.P.M.

CLIMB PERFORMANCE

Figure 5-13

PA-28-181

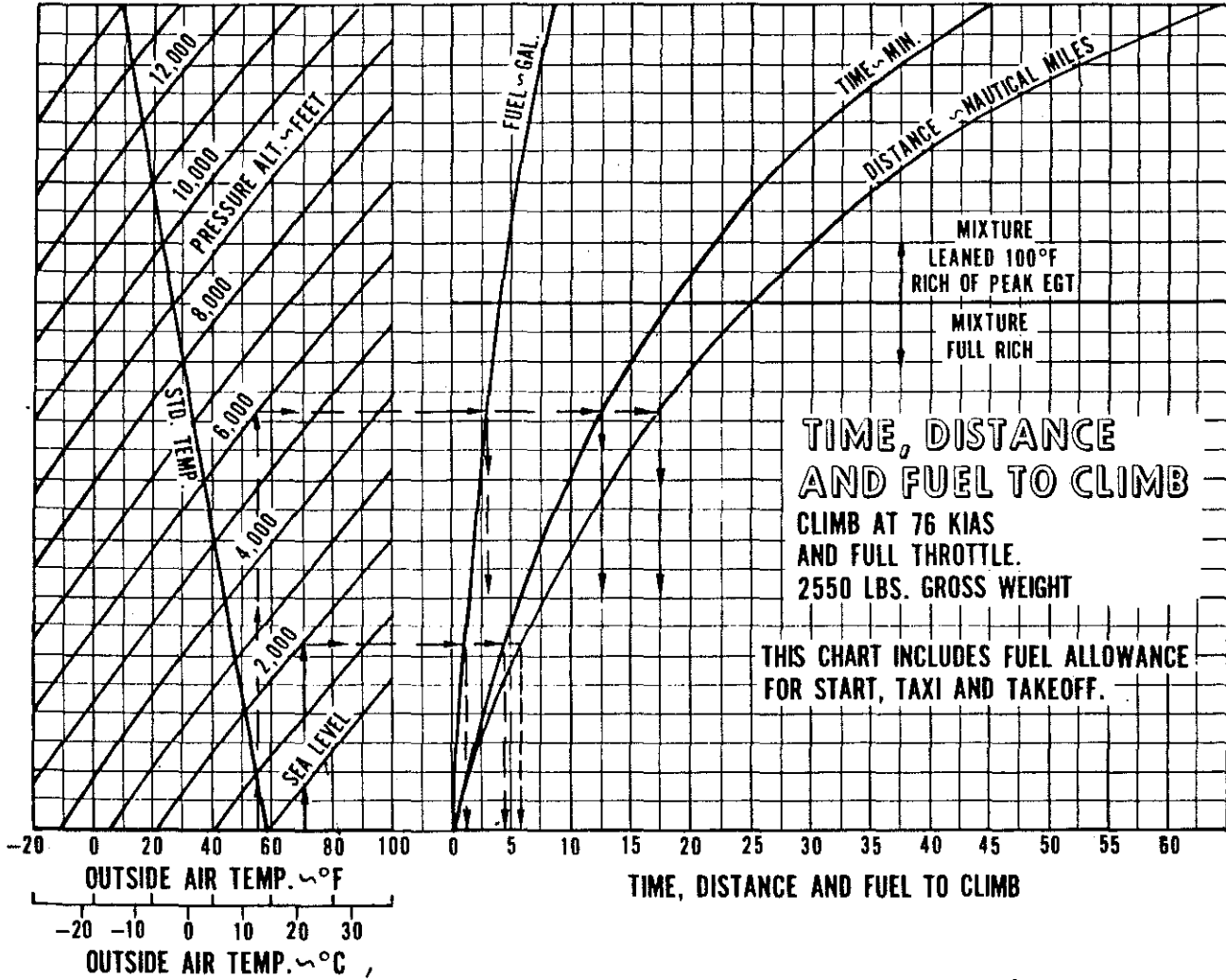

Example:

- Departure airport pressure altitude: 2000 ft.
- Departure airport temperature: 70°F
- Cruise pressure altitude: 6000 ft.
- Cruise OAT: 55°F
- Time to climb: 12.5 min. minus 4.5 min. = 8 min.
- Distance to climb: 17.5 miles minus 6.5 miles = 11 nautical miles
- Fuel to climb: 3 gal. minus 1 gal. = 2 gal.

TIME, DISTANCE AND FUEL TO CLIMB

Figure 5-15

PA-28-181

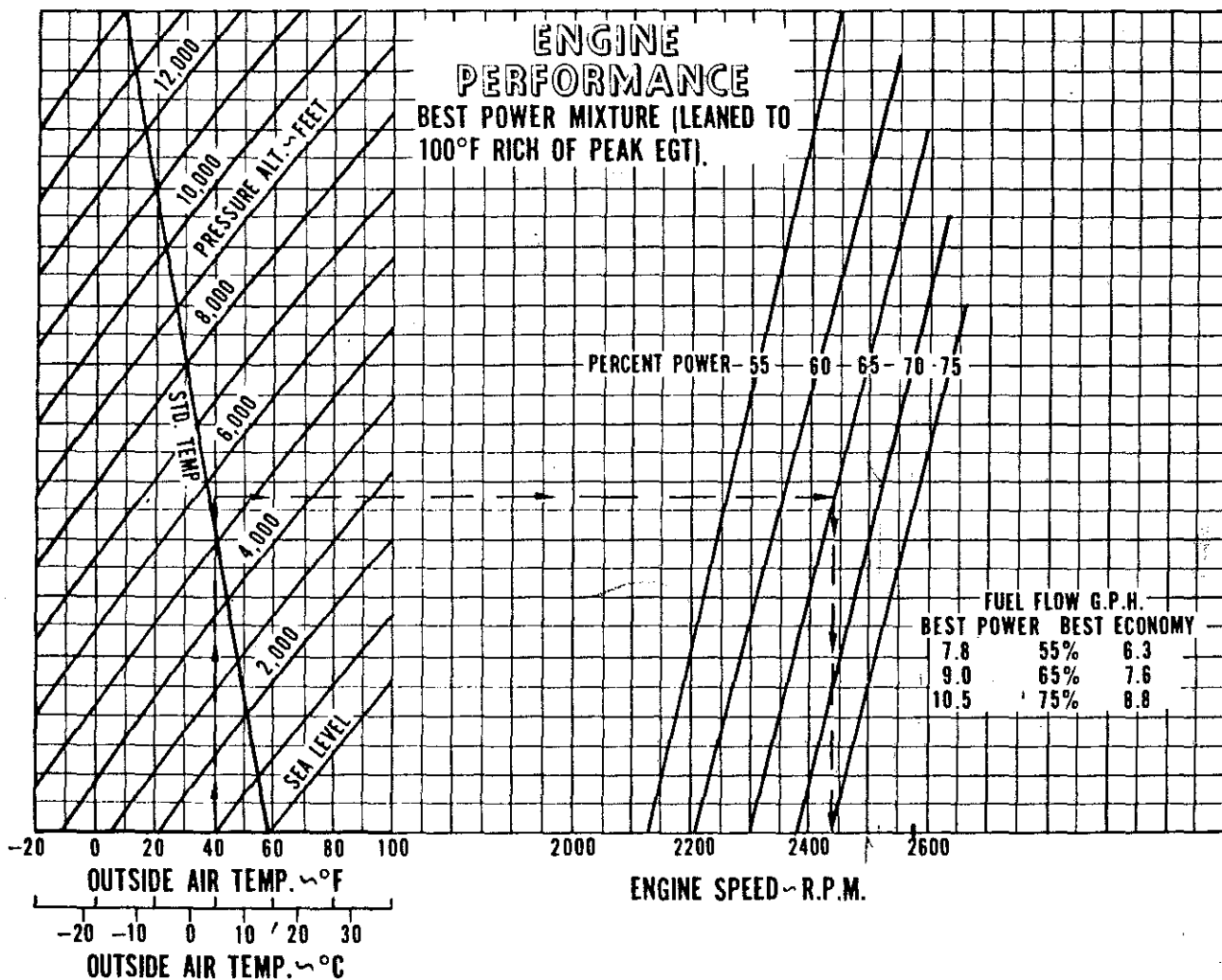

Example:

- Cruise pressure altitude: 5500 ft.
- Cruise OAT: 40°F
- Percent power: 65%
- Engine RPM: 2440 RPM

ENGINE PERFORMANCE (SERIAL NOS. 28-7790001 THROUGH 7790607)

Figure 5-17

ISSUED: JUNE 18, 1976
REVISED: JULY 12, 1977

REPORT: VB-790
5-19

PA-28-181

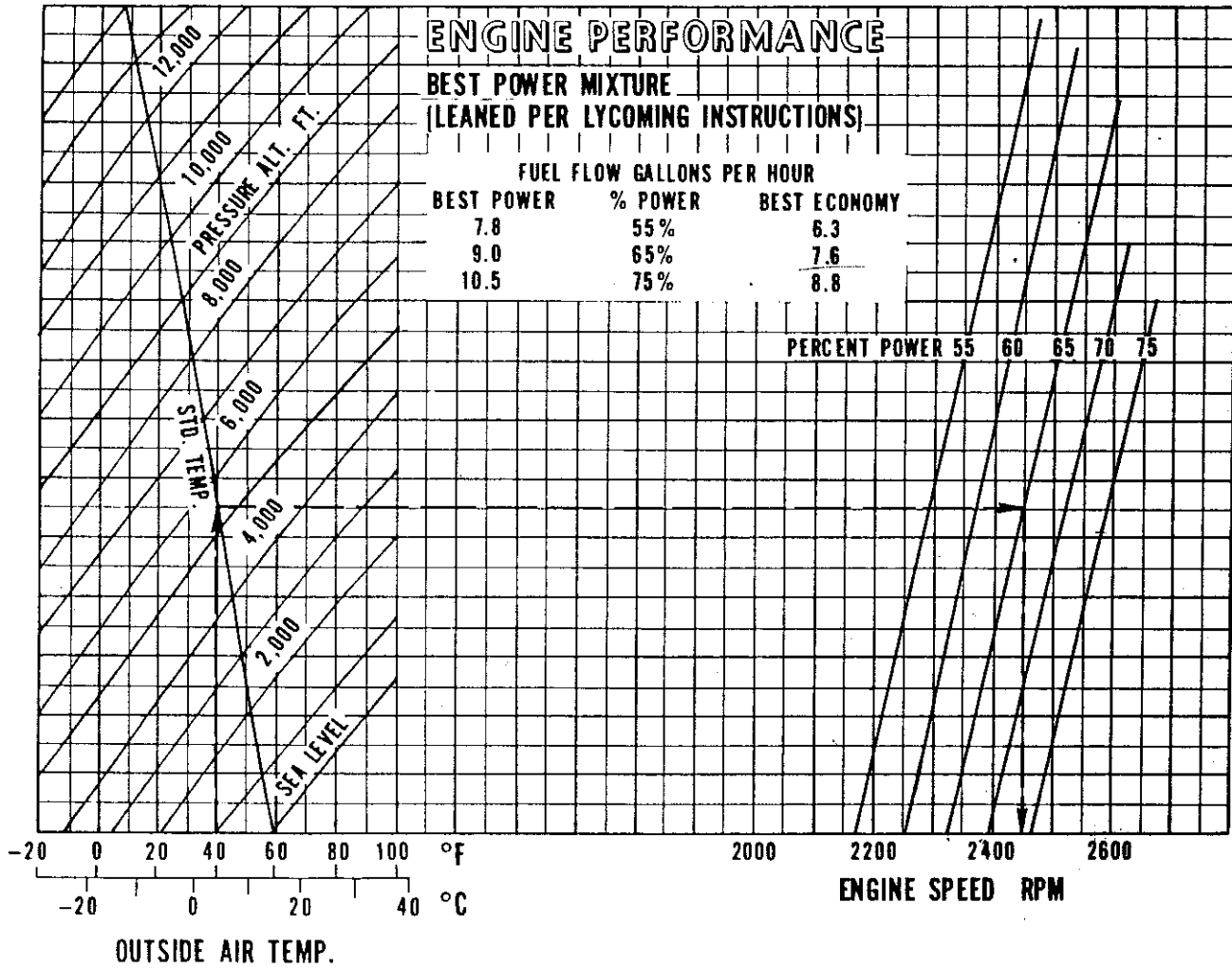

Example:

- Cruise pressure altitude: 5500 ft.
- Cruise OAT: 40°F
- Percent power: 65%
- Engine RPM: 2450 RPM

ENGINE PERFORMANCE (SERIAL NOS. 28-7890001 AND UP)

Figure 5-18

PA-28-181

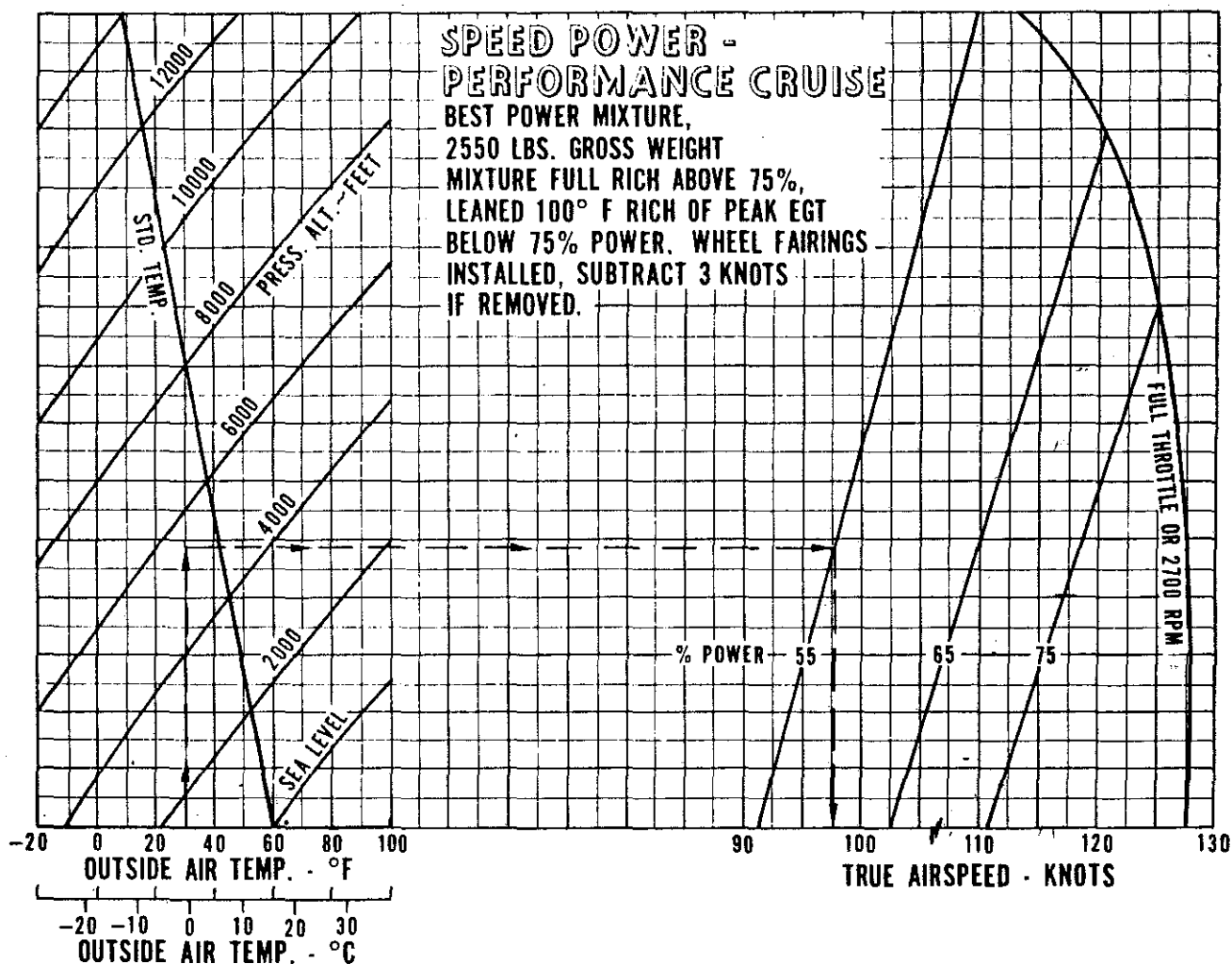

Example:
 Cruise pressure altitude: 5500 ft.
 Cruise OAT: 30°F
 Power: 55%
 True airspeed: 97.5 knots

SPEED POWER - PERFORMANCE CRUISE (SERIAL NOS. 28-7790001 THROUGH 7790607)

Figure 5-19

ISSUED: JUNE 18, 1976
 REVISED: JULY 12, 1977

REPORT: VB-790
 5-21

PA-28-181

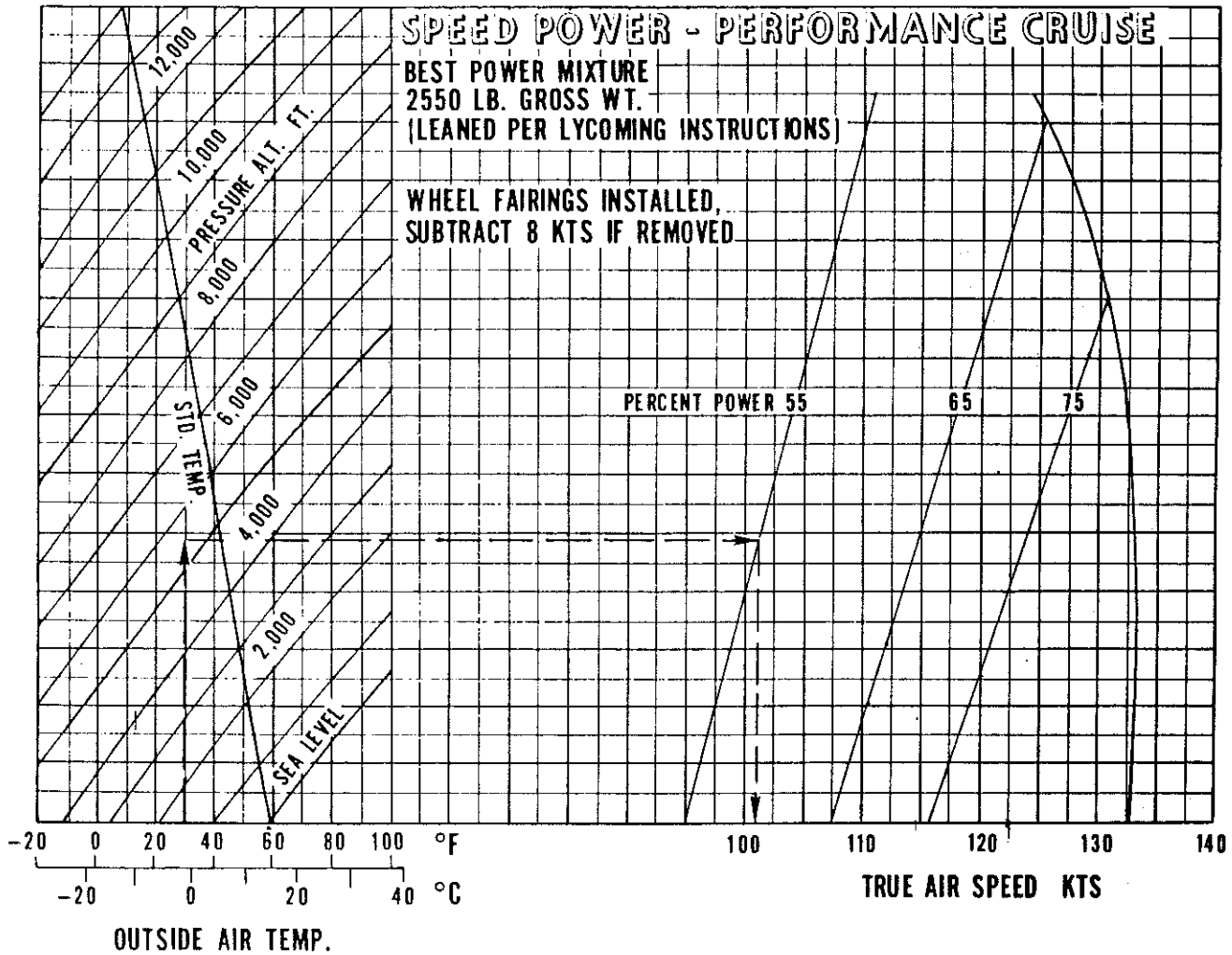

Example:
Cruise pressure altitude: 5500 ft.
Cruise OAT: 30° F
Power setting: 55%
True airspeed: 101 knots

SPEED POWER - PERFORMANCE CRUISE (SERIAL NOS. 28-7890001 AND UP)

Figure 5-20

NP6

PA-28-181

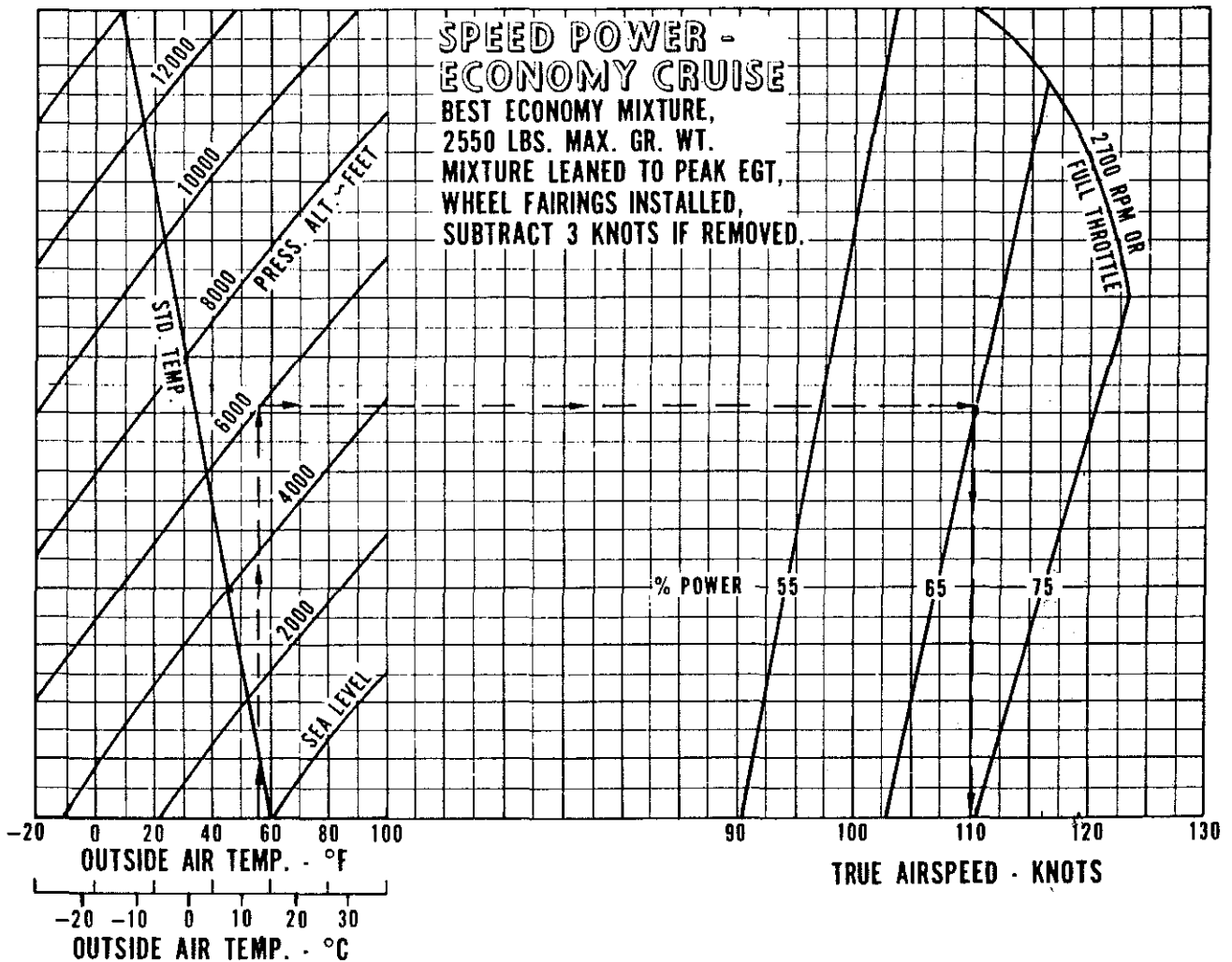

Example:

- Cruise pressure altitude: 6000 ft.
- Cruise OAT: 55°F
- Power: 65%
- True airspeed: 110 knots

SPEED POWER - ECONOMY CRUISE (SERIAL NOS. 28-7790001 THROUGH 7790607)

Figure 5-21

ISSUED: JUNE 18, 1976
 REVISED: JULY 12, 1977

REPORT: VB-790
 5-23

PA-28-181

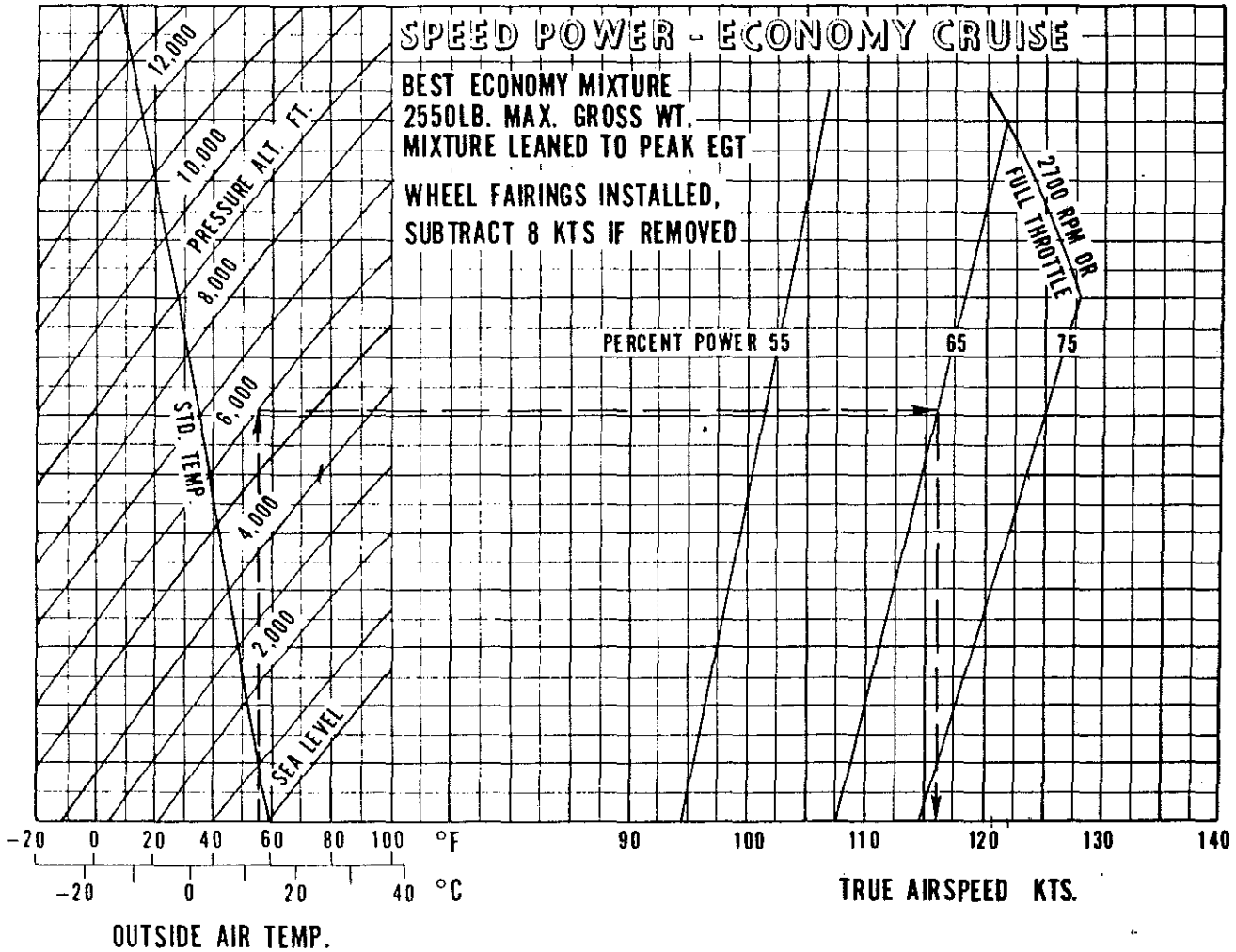

Example:

- Cruise pressure altitude: 6000 ft.
- Cruise OAT: 55° F
- Power setting: 65%
- True airspeed: 116 knots

SPEED POWER - ECONOMY CRUISE (SERIAL NOS. 28-7890001 AND UP)

Figure 5-22

NPA

PA-28-181

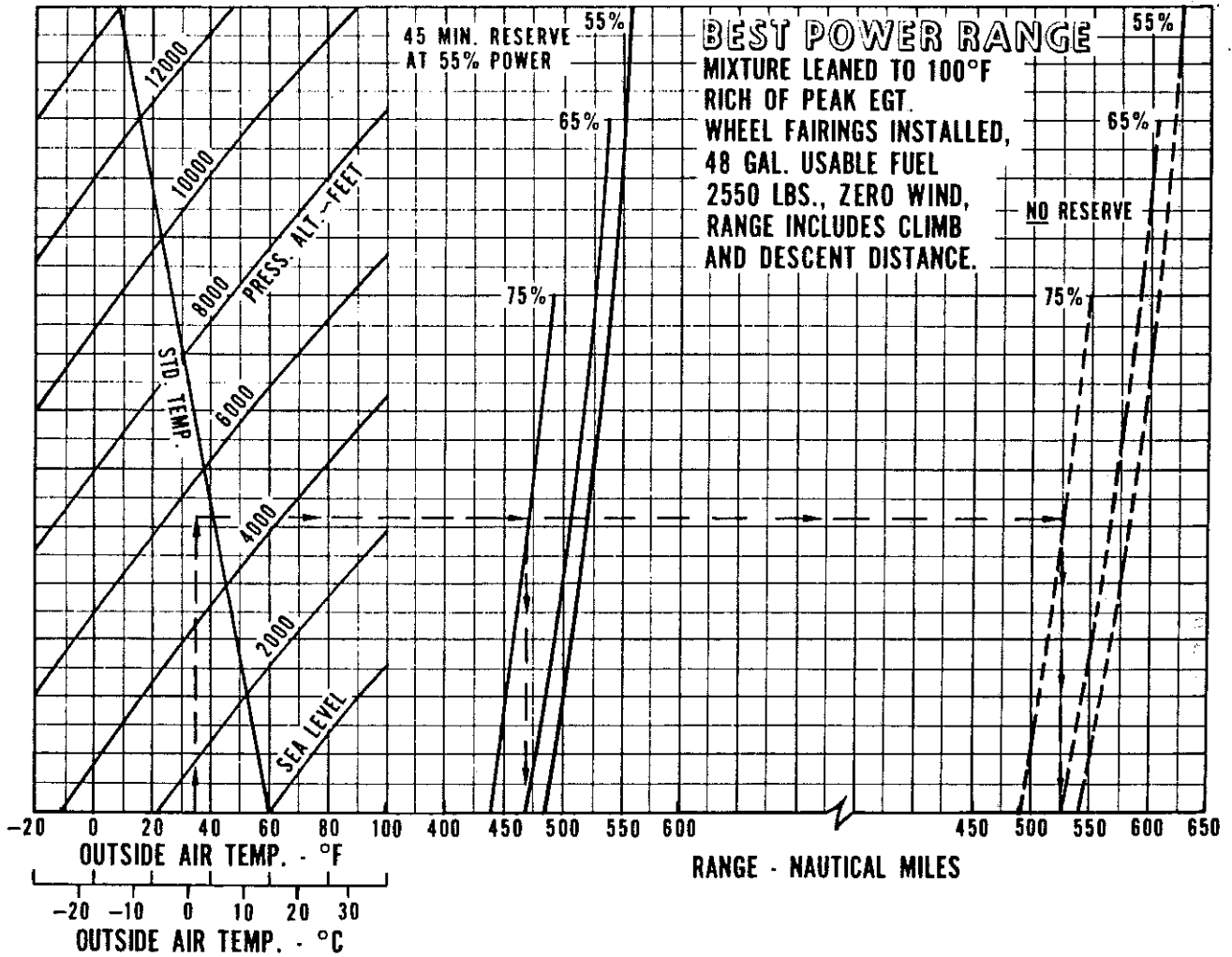

Example:

- Cruise pressure altitude: 5500 ft.
- Cruise OAT: 35°F
- Power setting: 75%
- Range (with reserve): 470 nautical miles
- Range (no reserve): 525 nautical miles

BEST POWER MIXTURE RANGE (SERIAL NOS. 28-7790001 THROUGH 7790607)

Figure 5-23

ISSUED: JUNE 18, 1976
REVISED: JULY 12, 1977

REPORT: VB-790
5-25

PA-28-181

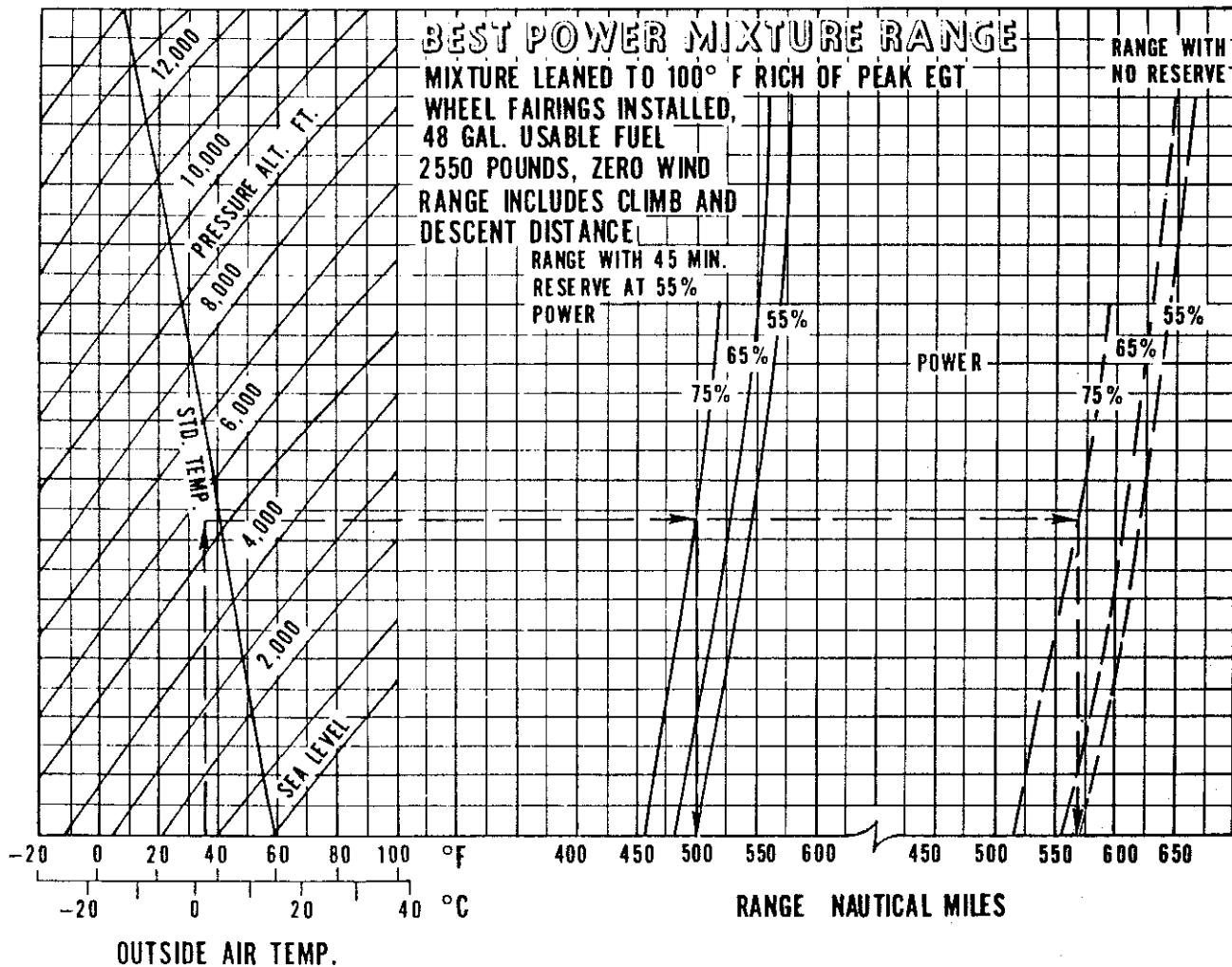

Example:

- Cruise pressure altitude: 5500 ft.
- Cruise OAT: 35° F
- Power setting: 75%
- Range (with reserve): 500 nautical miles
- Range (no reserve): 570 nautical miles

BEST POWER MIXTURE RANGE (SERIAL NOS. 28-7890001 AND UP)

Figure 5-24

NPQ

PA-28-181

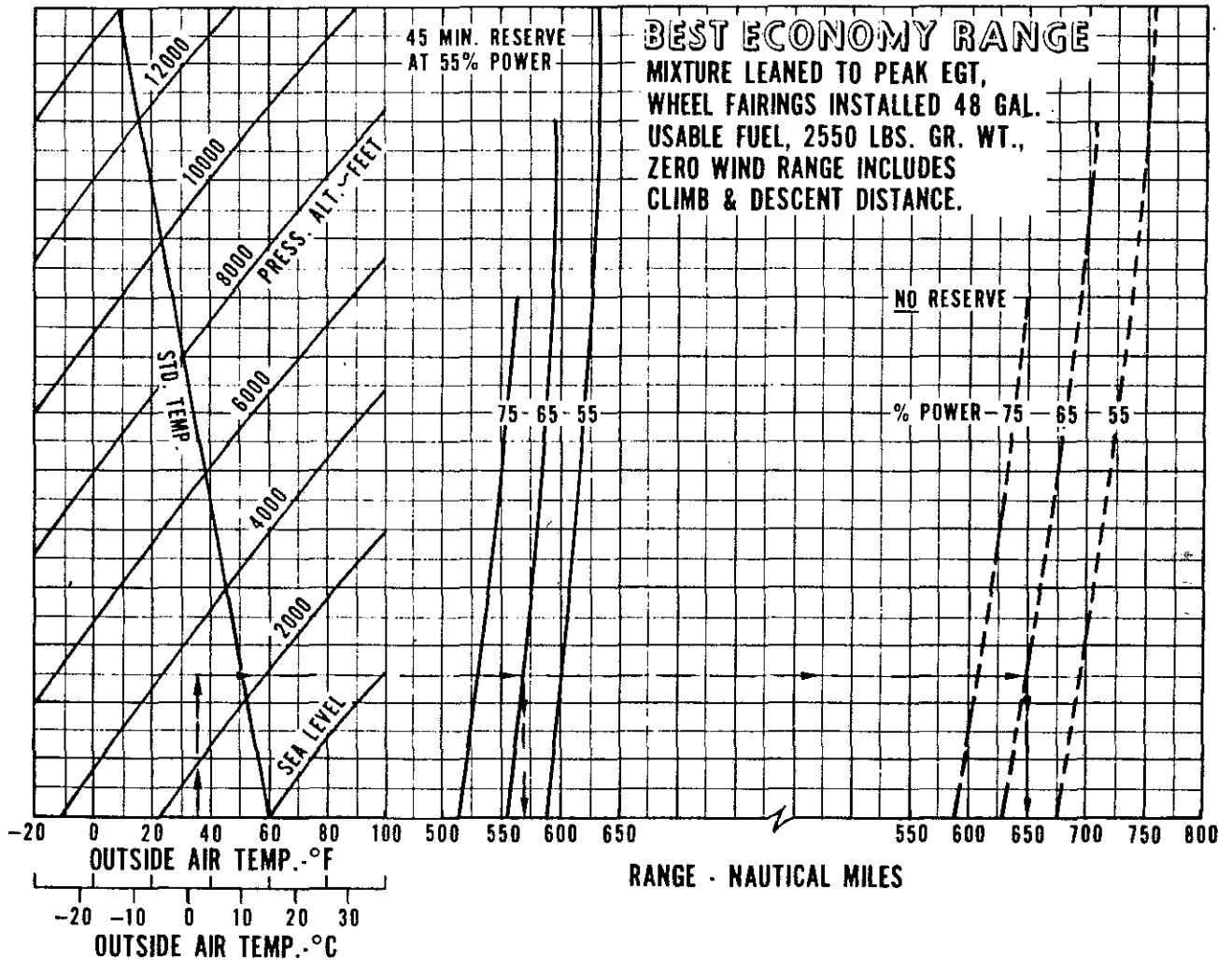

Example:

- Cruise pressure altitude: 3000 ft.
- Cruise OAT: 35°F
- Power setting: 65%
- Range (with reserve): 570 nautical miles
- Range (no reserve): 650 nautical miles

BEST ECONOMY MIXTURE RANGE (SERIAL NOS. 28-7790001 THROUGH 7790607)

Figure 5-25

PA-28-181

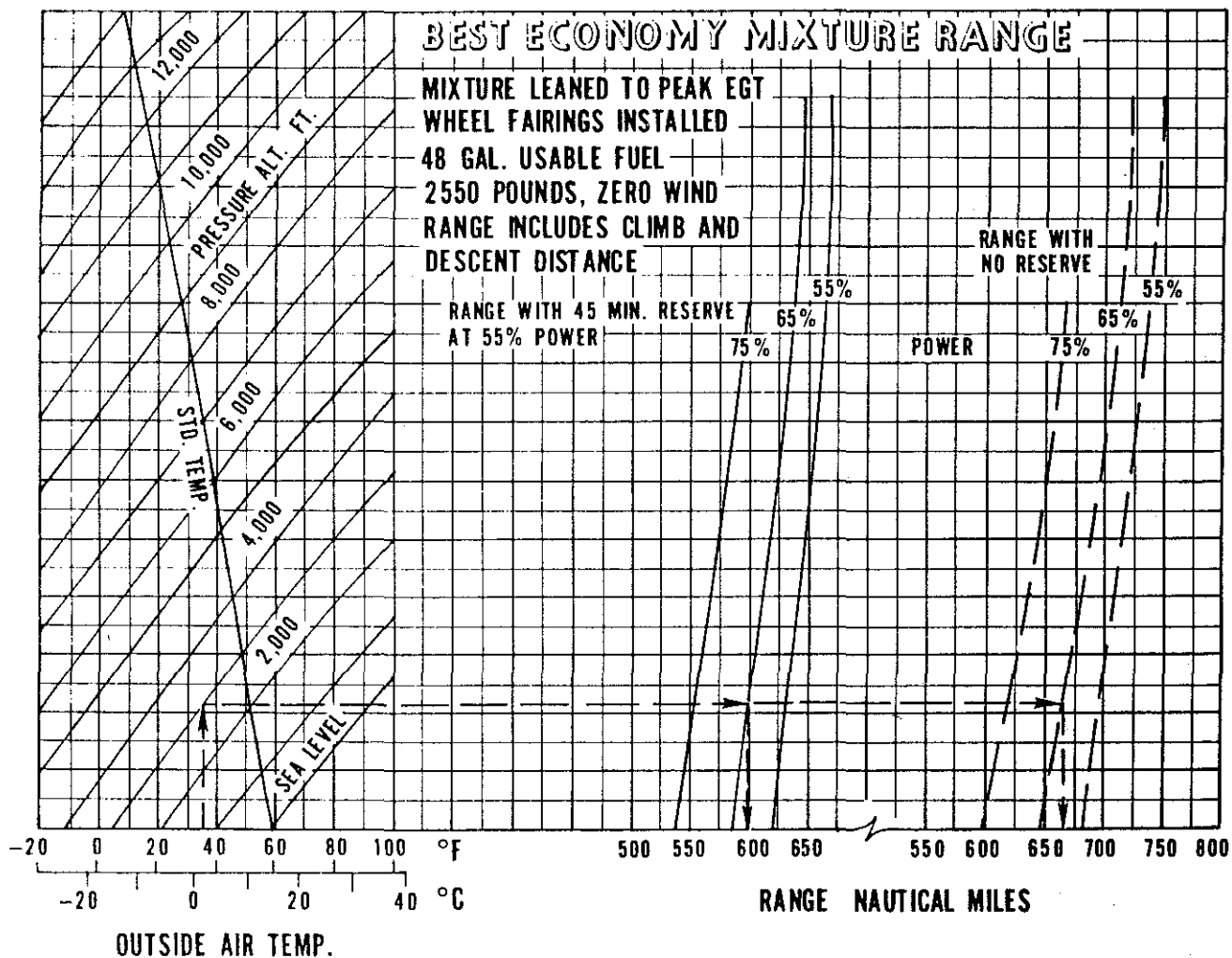

Example:

- Cruise pressure altitude: 3000 ft.
- Cruise OAT: 35°F
- Power setting: 65%
- Range (with reserve): 600 nautical miles
- Range (no reserve): 660 nautical miles

BEST ECONOMY MIXTURE RANGE (SERIAL NOS. 28-7890001 AND UP)

Figure 5-26

NPR

PA-28-181

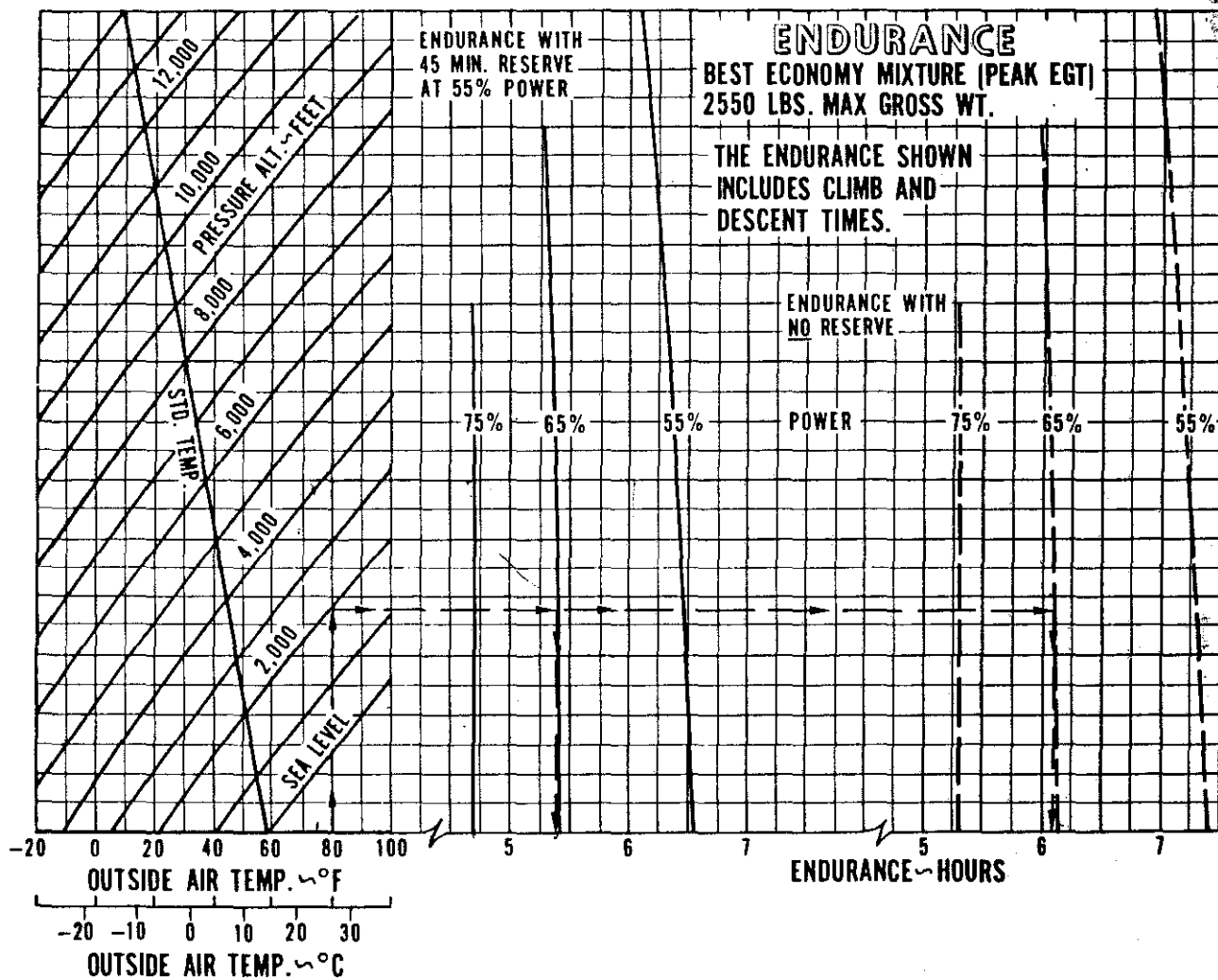

Example:

- Cruise pressure altitude: 2000 ft.
- Cruise OAT: 80°F
- Power setting: 65%
- Endurance (with reserve): 5.37 hrs.
- Endurance (no reserve): 6.1 hrs.

ENDURANCE

Figure 5-27

PA-28-181

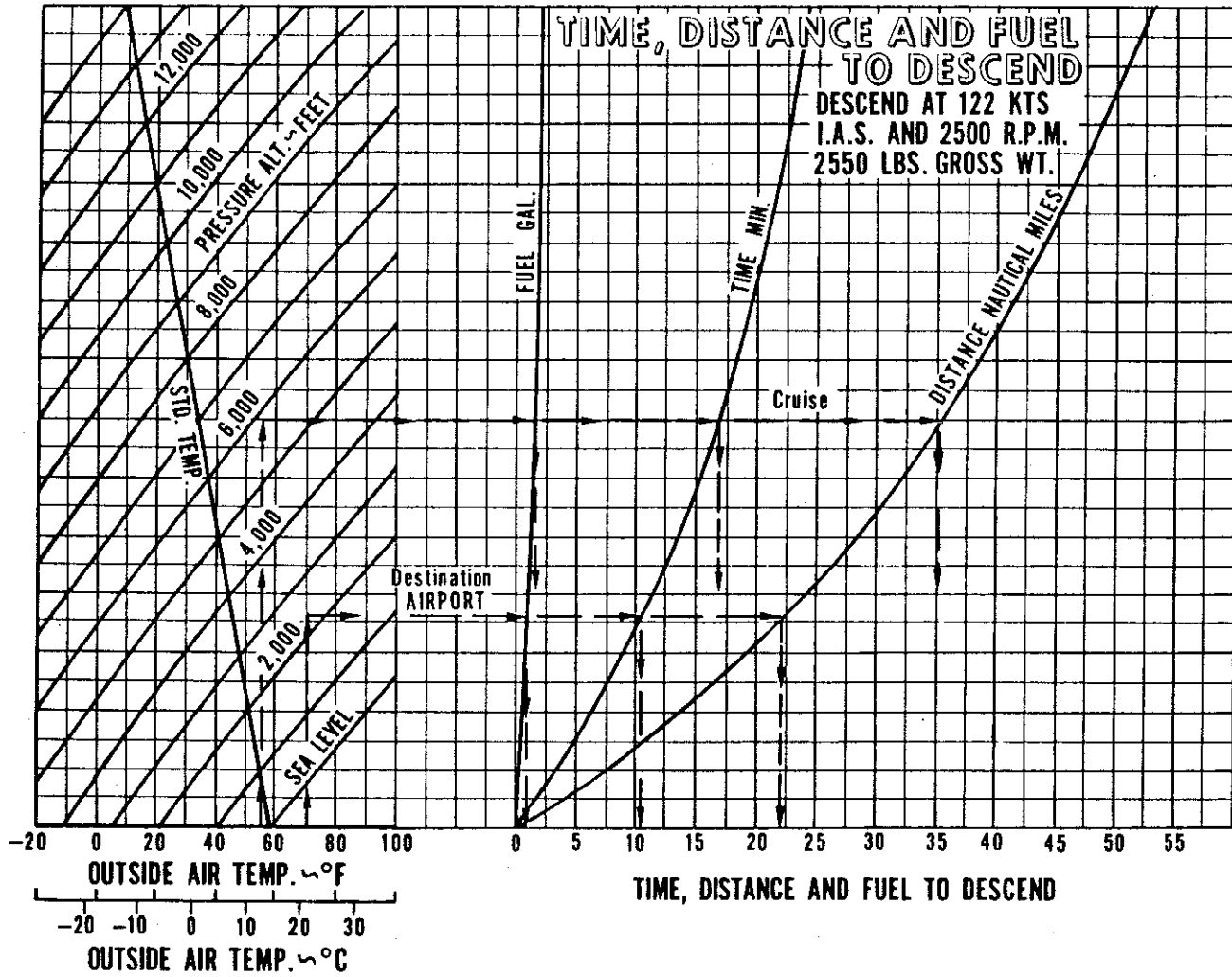

Example:

- Cruise pressure altitude: 6000 ft.
- Cruise OAT: 55°F
- Destination airport pressure altitude: 2300 ft.
- Destination airport temperature: 70°F
- Fuel to descend: (1.7 gal. minus 1 gal.) = .7 gal.
- Time to descend: (17 min. minus 10.5 min.) = 6.5 min.
- Distance to descend (35 miles minus 22 miles) = 13 nautical miles

TIME, DISTANCE AND FUEL TO DESCEND

Figure 5-29

PA-28-181

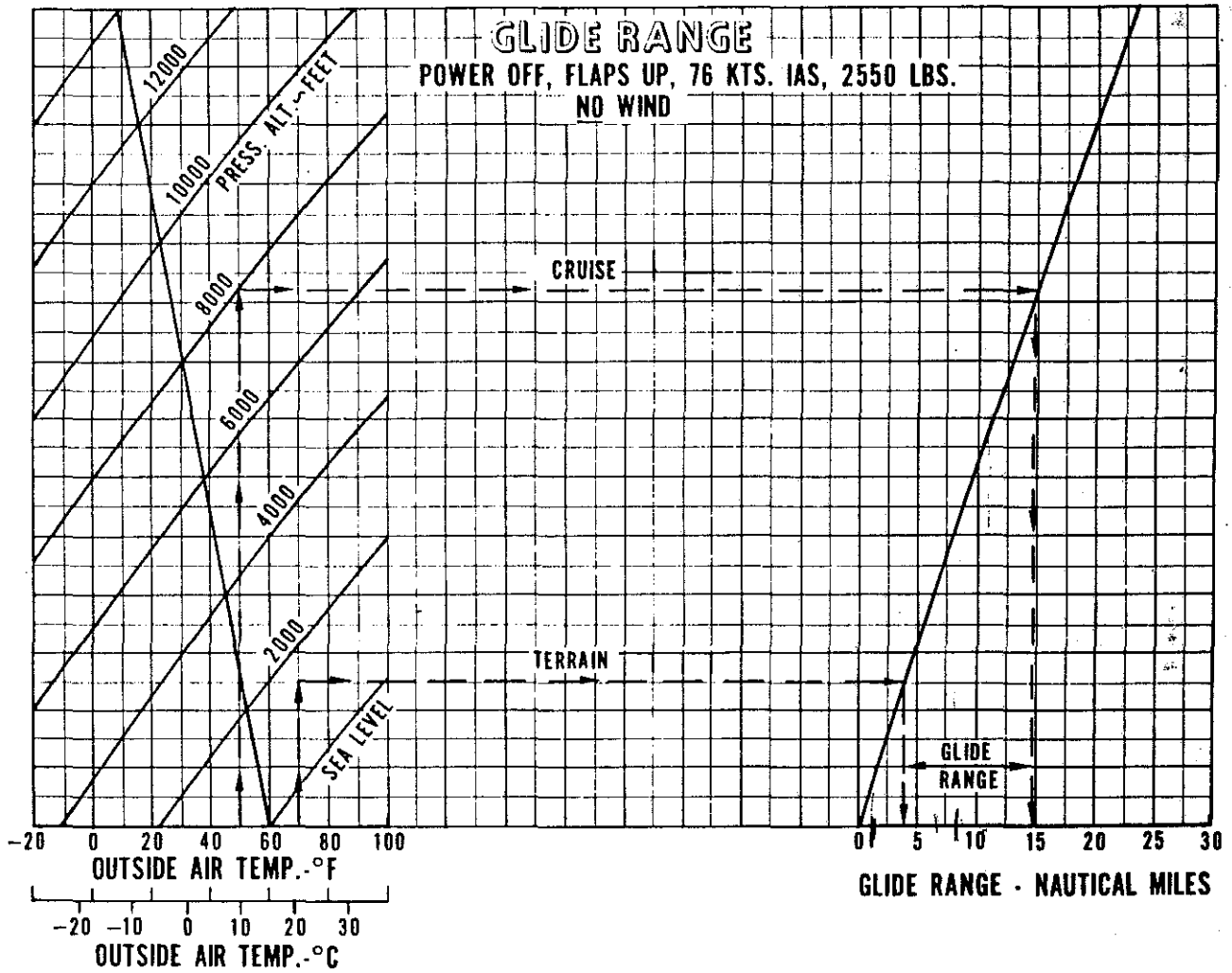

Example:

Cruise pressure altitude: 8000 ft.

Cruise OAT: 50°F

Terrain pressure altitude: 1500 ft.

Terrain temperature: 70°F

Glide Range: 14.5 miles minus 3.5 miles = 11 nautical miles

GLIDE RANGE

Figure 5-31

PA-28-181

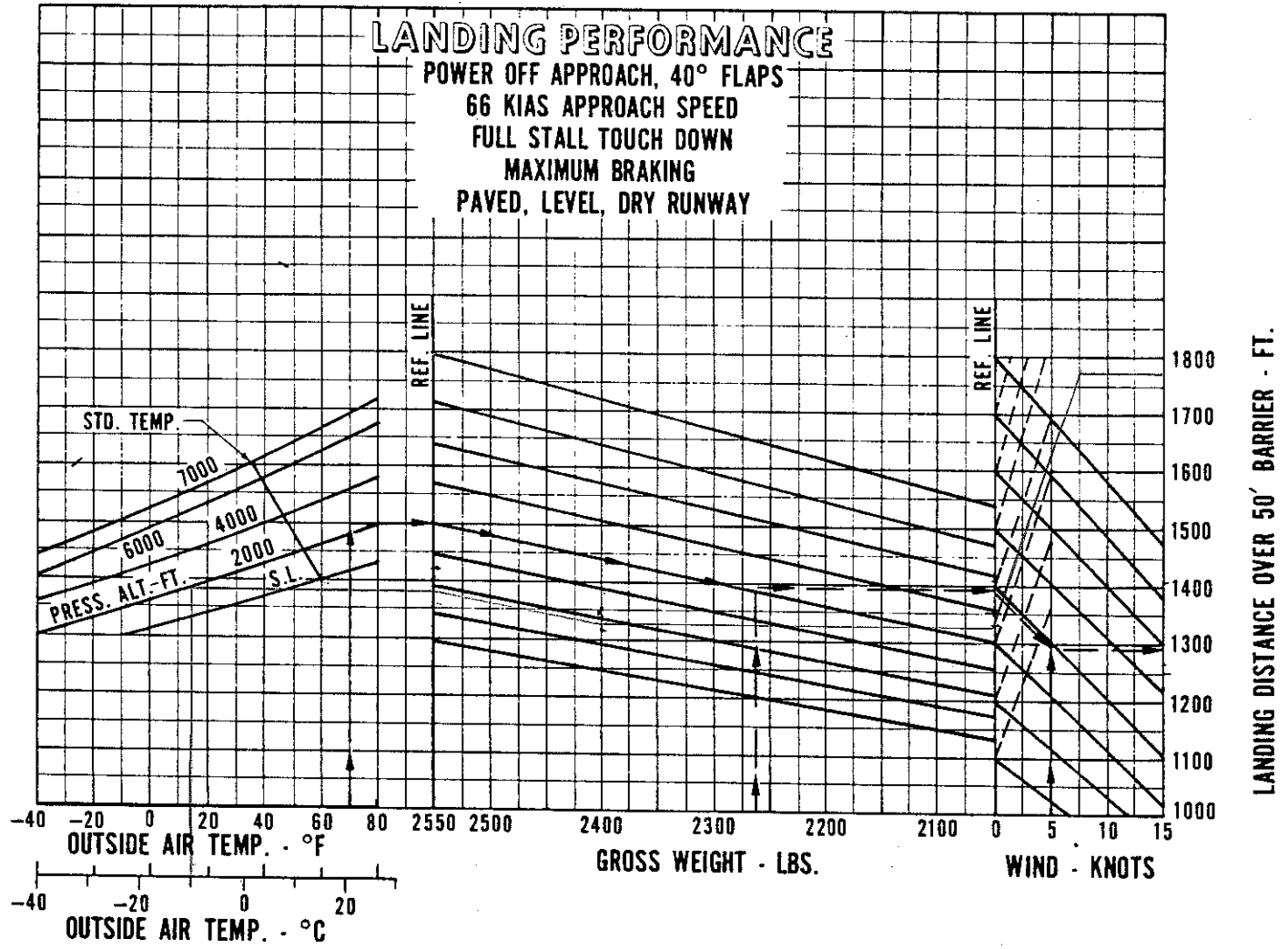

Example:
 Airport pressure altitude: 2300 ft.
 Gross weight: 2264
 Temperature: 70°F
 Wind: 5 knots (headwind)
 Landing distance: 1290 ft.

LANDING PERFORMANCE

Figure 5-33

PA-28-181

LANDING GROUND ROLL
POWER OFF APPROACH, 40° FLAPS
FULL STALL TOUCHDOWN
MAXIMUM BRAKING
PAVED, LEVEL, DRY RUNWAY

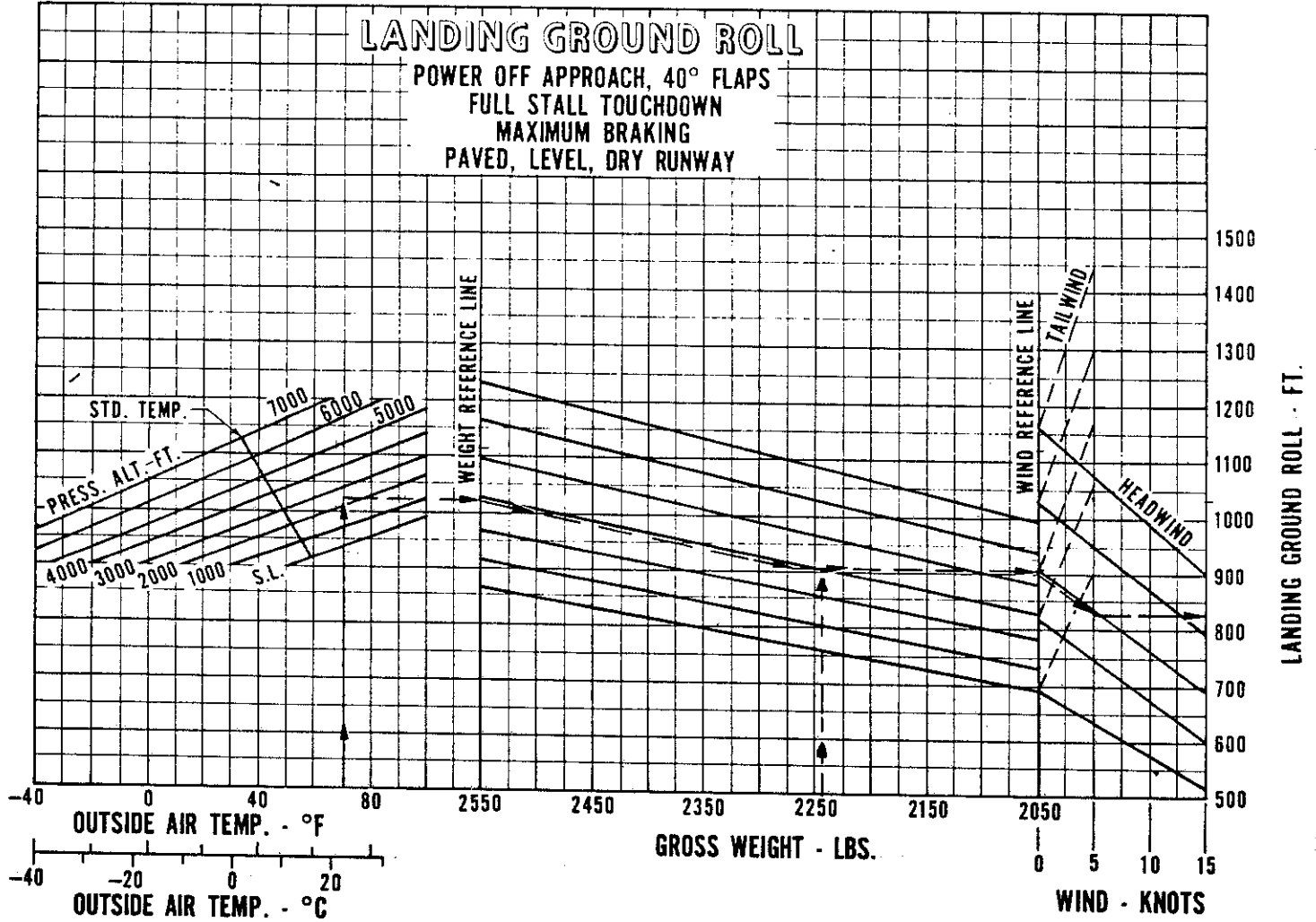

LANDING GROUND ROLL

Figure 5-35

Example:

- Airport pressure altitude: 2300 ft.
- Airport temperature: 70°F
- Gross weight: 2264 lbs.
- Wind: 5 knots (headwind)
- Ground roll: 825 ft.

THIS PAGE INTENTIONALLY LEFT BLANK

TABLE OF CONTENTS

SECTION 6

WEIGHT AND BALANCE

Paragraph No.		Page No.
6.1	General	6-1
6.3	Airplane Weighing Procedure	6-3
6.5	Weight and Balance Data and Record	6-6
6.7	Weight and Balance Determination for Flight	6-11
6.9	Equipment List	6-17
(a)	Propeller and Propeller Accessories	6-17
(b)	Engine and Engine Accessories	6-19
(c)	Landing Gear and Brakes	6-21
(d)	Electrical Equipment	6-23
(e)	Instruments	6-25
(f)	Miscellaneous	6-27
(g)	Engine and Engine Accessories (Optional Equipment)	6-29
(h)	Propeller and Propeller Accessories (Optional Equipment)	6-31
(i)	Landing Gear and Brakes (Optional Equipment)	6-33
(j)	Electrical Equipment (Optional Equipment)	6-35
(k)	Instruments (Optional Equipment)	6-37
(l)	Autopilots (Optional Equipment)	6-39
(m)	Radio Equipment (Optional Equipment)	6-41
(n)	Miscellaneous (Optional Equipment)	6-49

SECTION 6
WEIGHT AND BALANCE

6.1 GENERAL

In order to achieve the performance and flying characteristics which are designed into the airplane, it must be flown with the weight and center of gravity (C.G.) position within the approved operating range (envelope). Although the airplane offers flexibility of loading, it cannot be flown with the maximum number of adult passengers, full fuel tanks and maximum baggage. With the flexibility comes responsibility, the pilot must ensure that the airplane is loaded within the loading envelope before he makes a takeoff.

Misloading carries consequences for any aircraft. An overloaded airplane will not take off, climb or cruise as well as a properly loaded one. The heavier the airplane is loaded, the less climb performance it will have.

Center of gravity is a determining factor in flight characteristics. If the C.G. is too far forward in any airplane, it may be difficult to rotate for takeoff or landing. If the C.G. is too far aft, the airplane may rotate prematurely on takeoff or tend to pitch up during climb. Longitudinal stability will be reduced. This can lead to inadvertent stalls and even spins, and spin recovery becomes more difficult as the center of gravity moves aft of the approved limit.

A properly loaded airplane, however, will perform as intended. Before the airplane is licensed, a basic empty weight and C.G. location is computed (basic empty weight consists of the standard empty weight of the airplane plus the optional equipment). Using the basic empty weight and C.G. location, the pilot can determine the weight and C.G. position for the loaded airplane by computing the total weight and moment and then determining whether they are within the approved envelope.

The basic empty weight and C.G. location are recorded in the Weight and Balance Data Form (Figure 6-5) and the Weight and Balance Record (Figure 6-7). The current values should always be used. Whenever new equipment is added or any modification work is done, the mechanic responsible for the work is required to compute a new basic empty weight and C.G. position and to write these in the Aircraft Log Book and the Weight and Balance Record. The owner should make sure that it is done.

A weight and balance calculation is necessary in determining how much fuel or baggage can be boarded so as to keep within allowable limits. Check calculations prior to adding fuel to insure against improper loading.

The following pages are forms used in weighing an airplane and in computing basic empty weight, C.G. position, and useful load. Note that the useful load includes usable fuel, baggage, cargo and passengers. Following this is the method for computing takeoff weight and C.G.

THIS PAGE INTENTIONALLY LEFT BLANK

6.3 AIRPLANE WEIGHING PROCEDURE

At the time of licensing, Piper Aircraft Corporation provides each airplane with the basic empty weight and center of gravity location. This data is supplied by Figure 6-5.

The removal or addition of equipment or airplane modifications can affect the basic empty weight and center of gravity. The following is a weighing procedure to determine this basic empty weight and center of gravity location:

(a) Preparation

- (1) Be certain that all items checked in the airplane equipment list are installed in the proper location in the airplane.
- (2) Remove excessive dirt, grease, moisture, foreign items such as rags and tools from the airplane before weighing.
- (3) Defuel airplane. Then open all fuel drains until all remaining fuel is drained. Operate engine on each tank until all undrainable fuel is used and engine stops. Then add the unusable fuel (2.0 gallons total, 1.0 gallons each wing).

CAUTION

Whenever the fuel system is completely drained and fuel is replenished it will be necessary to run the engine for a minimum of 3 minutes at 1000 RPM on each tank to ensure no air exists in the fuel supply lines.

- (4) Fill with oil to full capacity.
 - (5) Place pilot and copilot seats in fourth (4th) notch, aft of forward position. Put flaps in the fully retracted position and all control surfaces in the neutral position. Tow bar should be in the proper location and all entrance and baggage doors closed.
 - (6) Weigh the airplane inside a closed building to prevent errors in scale readings due to wind.
- (b) Leveling
- (1) With airplane on scales, block main gear oleo pistons in the fully extended position.
 - (2) Level airplane (refer to Figure 6-3) deflating nose wheel tire, to center bubble on level.

(c) Weighing - Airplane Basic Empty Weight

- (1) With the airplane level and brakes released, record the weight shown on each scale. Deduct the tare, if any, from each reading.

Scale Position and Symbol	Scale Reading	Tare	Net Weight
Nose Wheel (N)			
Right Main Wheel (R)			
Left Main Wheel (L)			
Basic Empty Weight, as Weighed (T)	—	—	

WEIGHING FORM

Figure 6-1

(d) Basic Empty Weight Center of Gravity

- (1) The following geometry applies to the PA-28-181 airplane when it is level. Refer to Leveling paragraph 6.3 (b).

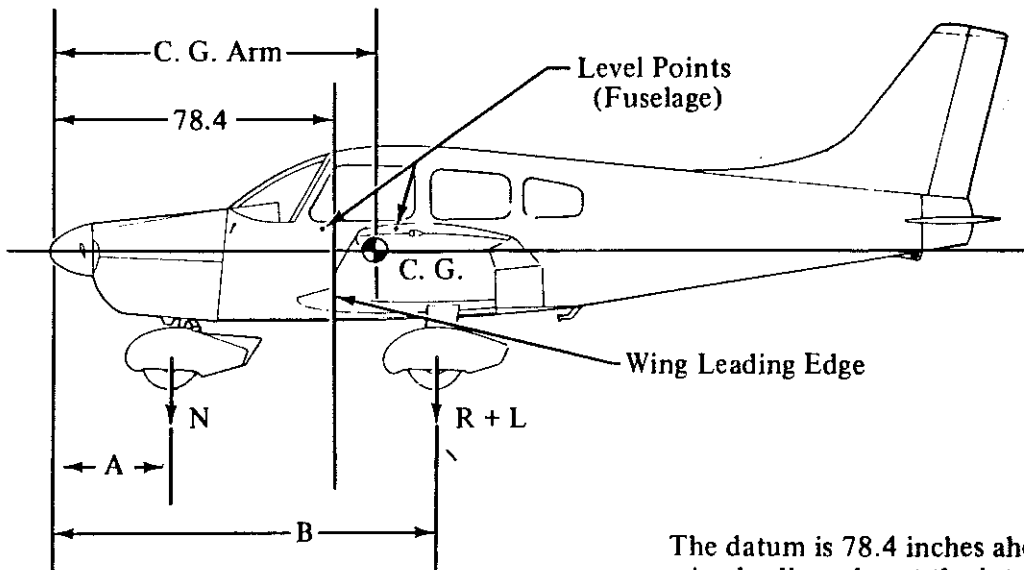

The datum is 78.4 inches ahead of the wing leading edge at the intersection of the straight and tapered section.

A = 31.0

B = 109.7

LEVELING DIAGRAM

Figure 6-3

- (2) The basic empty weight center of gravity (as weighed including optional equipment, full oil and unusable fuel) can be determined by the following formula:

$$\text{C.G. Arm} = \frac{N(A) + (R+L)(B)}{T} \text{ inches}$$

Where: $T = N + R + L$

6.5 WEIGHT AND BALANCE DATA AND RECORD

The Basic Empty Weight, Center of Gravity Location and Useful Load listed in Figure 6-5 are for the airplane as licensed at the factory. These figures apply only to the specific airplane serial number and registration number shown.

The basic empty weight of the airplane as licensed at the factory has been entered in the Weight and Balance Record (Figure 6-7). This form is provided to present the current status of the airplane basic empty weight and a complete history of previous modifications. Any change to the permanently installed equipment or modification which affects weight or moment must be entered in the Weight and Balance Record.

MODEL PA-28-181 CHEROKEE ARCHER II

Airplane Serial Number 28-7890340

Registration Number LN-NPQ

Date 1-23-78

THE WEIGHT AND BALANCE DATA SHOWN IN THIS REPORT ARE COMPUTED ON THE BASIS OF FEDERAL AVIATION ADMINISTRATION APPROVED PROCEDURES FOR ESTABLISHING FLEET WEIGHT AVERAGES.

AIRPLANE BASIC EMPTY WEIGHT

Item	Weight (Lbs)	x	C. G. Arm (Inches Aft of Datum)	=	Moment (In-Lbs)
Standard Empty Weight* XXXXXX Computed	1412.0		85.3		120482
Optional Equipment	135.0		97.3		13137
Basic Empty Weight	1547.0		86.4		133619

*The standard empty weight includes full oil capacity and 2.0 gallons of unusable fuel.

AIRPLANE USEFUL LOAD

(Gross Weight) - (Basic Empty Weight) = Useful Load

Normal Category (2550 lbs) - (1547.0 lbs) = 1003.0 lbs.

Utility Category (1950 lbs) - (1547.0 lbs) = 403.0 lbs.

THIS BASIC EMPTY WEIGHT, C.G. AND USEFUL LOAD ARE FOR THE AIRPLANE AS DELIVERED FROM THE FACTORY. REFER TO APPROPRIATE AIRCRAFT RECORD WHEN ALTERATIONS HAVE BEEN MADE.

SUPERSEDED

SEE REVISED WEIGHT & BALANCE

DATED JAN 27 1978

PIPER AIRCRAFT CORPORATION
VERO BEACH, FLORIDA

WEIGHT AND BALANCE DATA FORM

Figure 6-5

THIS PAGE INTENTIONALLY LEFT BLANK

MODEL PA-28-181 CHEROKEE ARCHER II

Airplane Serial Number _____

Registration Number _____

Date _____

AIRPLANE BASIC EMPTY WEIGHT

Item		Weight (Lbs)	x	C. G. Arm (Inches Aft of Datum)	=	Moment (In-Lbs)
Standard Empty Weight*	Actual Computed					
Optional Equipment						
Basic Empty Weight						

*The standard empty weight includes full oil capacity and 2.0 gallons of unusable fuel.

AIRPLANE USEFUL LOAD

(Gross Weight) - (Basic Empty Weight) = Useful Load

Normal Category (2550 lbs) - (lbs) = lbs.

Utility Category (2130 lbs) - (lbs) = lbs.

THIS BASIC EMPTY WEIGHT, C.G. AND USEFUL LOAD ARE FOR THE AIRPLANE AS LICENSED AT THE FACTORY. REFER TO APPROPRIATE AIRCRAFT RECORD WHEN ALTERATIONS HAVE BEEN MADE.

WEIGHT AND BALANCE DATA FORM

Figure 6-5

THIS PAGE INTENTIONALLY LEFT BLANK

6.7 WEIGHT AND BALANCE DETERMINATION FOR FLIGHT

- (a) Add the weight of all items to be loaded to the basic empty weight.
- (b) Use the Loading Graph (Figure 6-13) to determine the moment of all items to be carried in the airplane.
- (c) Add the moment of all items to be loaded to the basic empty weight moment.
- (d) Divide the total moment by the total weight to determine the C.G. location.
- (e) By using the figures of item (a) and item (d) (above), locate a point on the C.G. range and weight graph (Figure 6-15). If the point falls within the C.G. envelope, the loading meets the weight and balance requirements.

	Weight (Lbs)	Arm Aft Datum (Inches)	Moment (In-Lbs)
Basic Empty Weight	1547.0	86.4	133619
Pilot and Front Passenger	340.0	80.5	27370
Passengers (Rear Seats)*	340.0	118.1	40154
Fuel (48 Gallon Maximum)	288.0	95.0	27360
Baggage*	35.0	142.8	4998
Total Loaded Airplane	2550	91.6	233501

The center of gravity (C.G.) of this sample loading problem is at 91.6 inches aft of the datum line. Locate this point (91.6) on the C.G. range and weight graph. Since this point falls within the weight - C.G. envelope, this loading meets the weight and balance requirements.

IT IS THE RESPONSIBILITY OF THE PILOT AND AIRCRAFT OWNER TO INSURE THAT THE AIRPLANE IS LOADED PROPERLY.

*Utility Category Operation - No baggage or rear passengers allowed.

SAMPLE LOADING PROBLEM (NORMAL CATEGORY)

Figure 6-9

	Weight (Lbs)	Arm Aft Datum (Inches)	Moment (In-Lbs)
Basic Empty Weight			
Pilot and Front Passenger		80.5	
Passengers (Rear Seats)*		118.1	
Fuel (48 Gallon Maximum)		95.0	
Baggage*		142.8	
Total Loaded Airplane			

Totals must be within approved weight and C.G. limits. It is the responsibility of the airplane owner and the pilot to insure that the airplane is loaded properly. The Basic Empty Weight C.G. is noted on the Weight and Balance Data Form (Figure 6-5). If the airplane has been altered, refer to the Weight and Balance Record for this information.

*Utility Category Operation - No baggage or rear passengers allowed.

WEIGHT AND BALANCE LOADING FORM

Figure 6-11

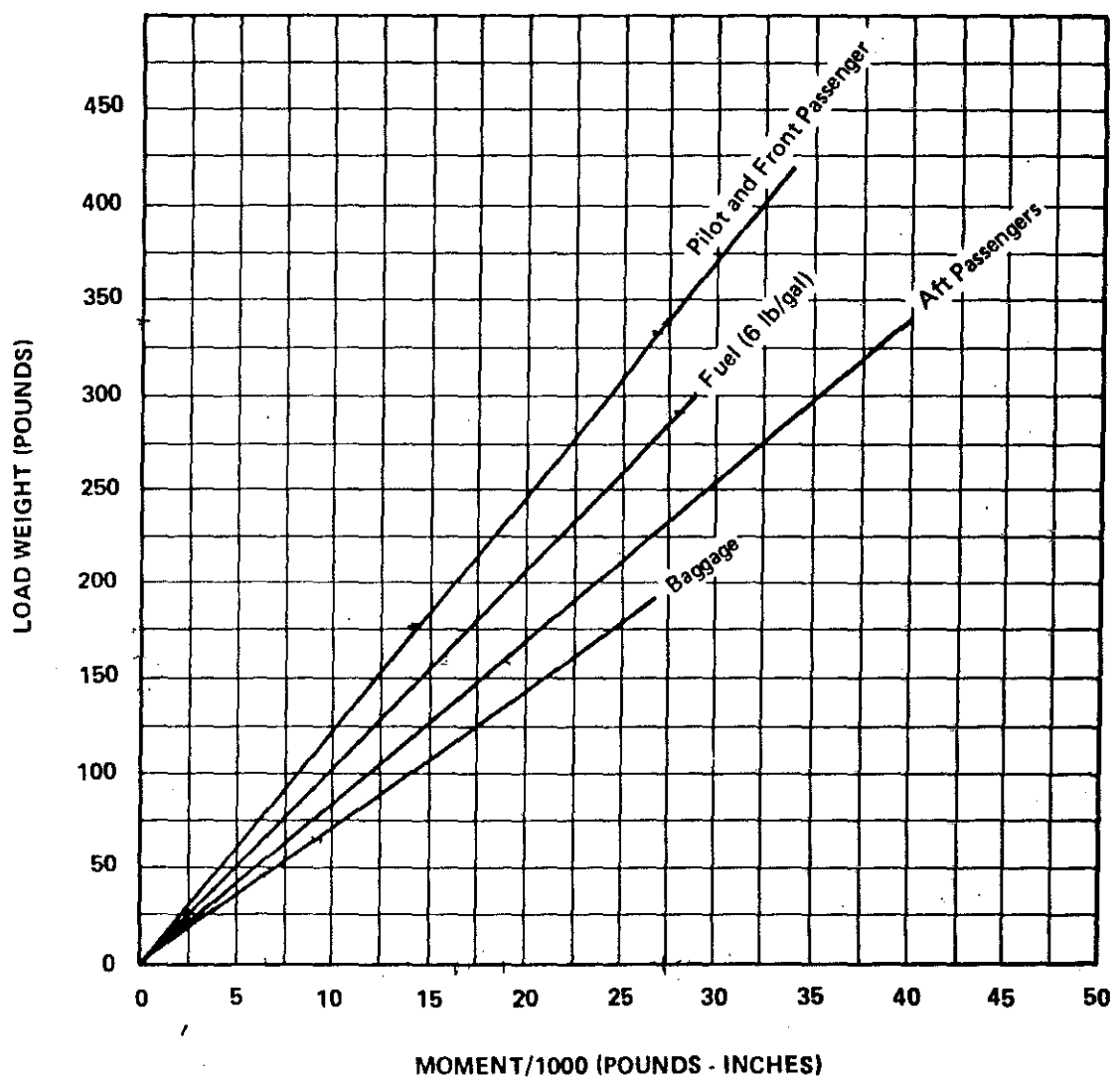

LOADING GRAPH
Figure 6-13

ISSUED: JUNE 18, 1976

REPORT: VB-790
6-13

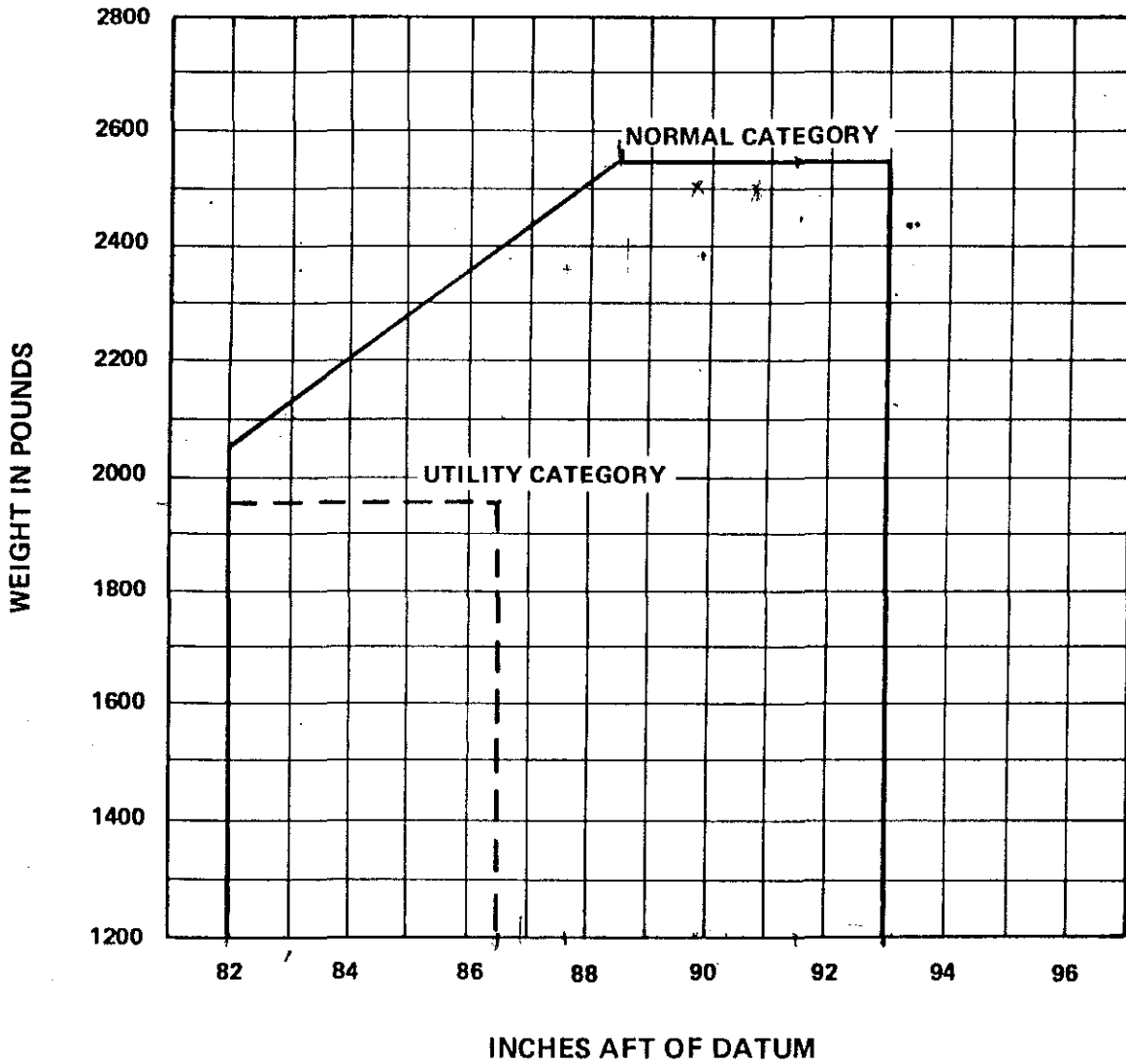

C. G. RANGE AND WEIGHT

Figure 6-15

MAJOR REPAIR AND ALTERATION
(Airframe, Powerplant, Propeller, or Appliance)

FOR FAA USE ONLY

OFFICE IDENTIFICATION

INSTRUCTIONS: Print or type all entries. See FAR 43.9, FAR 43 Appendix B, and AC 43.9-1 (or subsequent revision thereof) for instructions and disposition of this form.

1. AIRCRAFT	MAKE Piper	MODEL PA28-181
	SERIAL NO. 28-7890340	NATIONALITY AND REGISTRATION MARK LN-NPQ
2. OWNER	NAME (As shown on registration certificate) Piper Aircraft Corporation	ADDRESS (As shown on registration certificate) P.O. Box 1328 Vero Beach, Florida 32960

3. FOR FAA USE ONLY

4. UNIT IDENTIFICATION				5. TYPE	
UNIT	MAKE	MODEL	SERIAL NO.	REPAIR	ALTERATION
AIRFRAME	***** (As described in item 1 above) *****				X
POWERPLANT					
PROPELLER					
APPLIANCE	TYPE				
	MANUFACTURER				

6. CONFORMITY STATEMENT

A. AGENCY'S NAME AND ADDRESS Piper Aircraft Corporation P.O. Box 1328 Vero Beach, Florida 32960	B. KIND OF AGENCY <input type="checkbox"/> U.S. CERTIFICATED MECHANIC <input type="checkbox"/> FOREIGN CERTIFICATED MECHANIC <input type="checkbox"/> CERTIFICATED REPAIR STATION <input checked="" type="checkbox"/> MANUFACTURER	C. CERTIFICATE NO. FAA DOA SO-1
---	--	---

D. I certify that the repair and/or alteration made to the unit(s) identified in item 4 above and described on the reverse or attachments hereto have been made in accordance with the requirements of Part 43 of the U.S. Federal Aviation Regulations and that the information furnished herein is true and correct to the best of my knowledge.

DATE JAN 27 1978	SIGNATURE OF AUTHORIZED INDIVIDUAL <i>Michael S. Wellwith</i>
----------------------------	--

7. APPROVAL FOR RETURN TO SERVICE

Pursuant to the authority given persons specified below, the unit identified in item 4 was inspected in the manner prescribed by the Administrator of the Federal Aviation Administration and is: APPROVED REJECTED

BY	FAA FLT. STANDARDS INSPECTOR	<input checked="" type="checkbox"/> MANUFACTURER	INSPECTION AUTHORIZATION	OTHER (Specify)
	FAA DESIGNEE	REPAIR STATION	CANADIAN DEPARTMENT OF TRANSPORT INSPECTOR OF AIRCRAFT	

DATE OF APPROVAL OR REJECTION JAN 27 1978	CERTIFICATE OR DESIGNATION NO. DOA SO-1	SIGNATURE OF AUTHORIZED INDIVIDUAL <i>Robert R. Ormrod</i> ROBERT R. ORMROD
---	---	--

NOTICE

Weight and balance or operating limitation changes shall be entered in the appropriate aircraft record. An alteration must be compatible with all previous alterations to assure continued conformity with the applicable airworthiness requirements.

8. DESCRIPTION OF WORK ACCOMPLISHED (If more space is required, attach additional sheets. Identify with aircraft nationality and registration mark and date work completed.)

Installed a Second Altimeter, Piper Aircraft Corporation Part #550-491 (initially approved on FA26-181, SE-GKS, 28-7690317 by Piper DCA Engineering on May 24, 1976).

1. The altimeter is located in the position normally used for a DME installation in a panel approximately 4" X 6", fabricated of 2024T-3 .062 aluminum with reference to AC43.13-2, Chapter 2. The panel assembly is secured to the instrument panel structure with four (4) AN526-6-R screws. The altimeter is mounted in the center of the panel with reference to Piper Aircraft Corporation Drawing #66691.

2. The elbow at the alternate static source was replaced with Piper Aircraft Corporation Part #488-380 "T" fitting. The pitot line, Piper Aircraft Corporation Part #95153-173, is installed from the "T" fitting to the #2 altimeter and secured to prevent movement.

3. FAR 91.170, Static System, complied with.

4. No electrical power required for this installation.

5. Aircraft Equipment List and Weight and Balance are revised.

6. Aircraft flown for function check.

-----END-----

ADDITIONAL SHEETS ARE ATTACHED

6.9 EQUIPMENT LIST

The following is a list of equipment which may be installed in the PA-28-181. It consists of those items used for defining the configuration of an airplane when the basic empty weight is established at the time of delivery. Only those standard items which are alternate standard items and those required to be listed by the certificating authority (FAA) are presented. Items marked with an "X" are those items which were installed on the airplane described below as delivered by the manufacturer.

PIPER AIRCRAFT CORPORATION

PA-28-181 CHEROKEE ARCHER II

SERIAL NO. 28-7890340 REGISTRATION NO. LN-NPO DATE: 1-23-78

(a) Propeller and Propeller Accessories

Item No.	Item	Mark if Instl.	Weight (Pounds)	Arm (In.) Aft Datum	Moment (Lb-In.)
1	Propeller, Sensenich 76EM8S5-0-60, Piper Spec. PS50077-8 Cert. Basis - TC P4EA				
3	Propeller, Sensenich 76EM8S5-0-62, Piper Spec. PS50077-42 Cert. Basis - TC P4EA				

ISSUED: JUNE 18, 1976
REVISED: JULY 12, 1977

REPORT: VB-790
6-17

THIS PAGE INTENTIONALLY LEFT BLANK

(b) Engine and Engine Accessories

Item No.	Item	Mark if Instl.	Weight (Pounds)	Arm (In.) Aft Datum	Moment (Lb-In.)
11	Engine - Lycoming Model O-360-A4M Piper Dwg. 62941-16 Cert. Basis - TC E286				
13	Oil Filter - Lycoming No. 75528 (AC *OF5578770) Cert. Basis - TC E286	_____	3.3	35.5	117
15	Oil Filter - Lycoming *LW-13743 (Champion *CH-48110) Cert. Basis - TC E286	<u> X </u>	2.8	35.5	99

THIS PAGE INTENTIONALLY LEFT BLANK

(c) Landing Gear and Brakes

Item No.	Item	Mark if Instl.	Weight (Pounds)	Arm (In.) Aft Datum	Moment (Lb-In.)
27	Two Main Wheel Assemblies Piper Dwg. 63370-0 & -1				
	a. Cleveland Aircraft Products Wheel Assembly No. 40-86 Brake Assembly No. 30-55 Cert. Basis - TSO C26a				
	b. Two Main 4-Ply Rating Tires 6.00-6 with Regular Tubes Cert. Basis - TSO C62				
29	One Nose Wheel				
	a. Cleveland Aircraft Products Wheel Assembly No. 40-76B (Less Brake Drum) Cert Basis - TSO C26a	_____	4.3	31.0	133
	b. McCauley Industrial Corp. Wheel Assy. No. D-30625 Cert. Basis - TSO C26b	X _____	5.5	31.0	171
	c. One Nose Wheel 4-Ply Rating Tire 6.00-6 with Regular Tube Cert. Basis - TSO C62				

THIS PAGE INTENTIONALLY LEFT BLANK

TABLE OF CONTENTS

SECTION 7

DESCRIPTION AND OPERATION

OF THE AIRPLANE AND ITS SYSTEMS

Paragraph No.		Page No.
7.1	The Airplane	7-1
7.3	Airframe	7-1
7.5	Engine and Propeller	7-1
7.7	Landing Gear	7-3
7.9	Flight Controls	7-5
7.11	Engine Controls	7-6
7.13	Fuel System	7-8
7.15	Electrical System	7-10
7.17	Vacuum System	7-15
7.19	Instrument Panel	7-16
7.21	Pitot-Static System	7-18
7.23	Heating and Ventilating System	7-21
7.25	Cabin Features	7-21
7.27	Baggage Area	7-22
7.29	Stall Warning	7-22
7.31	Finish	7-22
7.33	Air Conditioning	7-23
7.35	Piper External Power	7-24
7.37	Emergency Locator Transmitter	7-24

SECTION 7
DESCRIPTION AND OPERATION
OF THE AIRPLANE AND ITS SYSTEMS

7.1 THE AIRPLANE

The PA-28-181 Cherokee is a single-engine, low-wing monoplane of all metal construction. It has four-place seating, two hundred pound baggage capacity, and a 180 horsepower engine.

7.3 AIRFRAME

The basic airframe, except for a tubular steel engine mount, steel landing gear struts, and other miscellaneous steel parts, is of aluminum alloy construction. The extremities - the wing tips, the cowling, the tail surfaces - are of fiberglass or ABS thermoplastic. Aerobatics are prohibited in this airplane since the structure is not designed for aerobatic loads.

The semi-tapered wings have a laminar flow type NACA 65₂-415 airfoil. The wings are attached to each side of the fuselage by insertion of the butt ends of the respective main spars into a spar box carry-through which is an integral part of the fuselage structure, providing, in effect, a continuous main spar with splices at each side of the fuselage. There are also fore and aft attachments at the rear spar and at an auxiliary front spar.

7.5 ENGINE AND PROPELLER

The Cherokee 181 is powered by a Lycoming O-360-A4M four cylinder, direct drive, horizontally opposed engine rated at 180 horsepower at 2700 rpm. It is furnished with a starter, a 60 ampere, 14 volt alternator, a shielded ignition, vacuum pump drive, a fuel pump, and a dry, automotive type carburetor air filter.

The exhaust system is made entirely from stainless steel and is equipped with dual mufflers. A heater shroud around the mufflers is provided to supply heat for the cabin and windshield defrosting.

The Sensenich 76EM8S5-0-60 or 76EM8S5-0-62 fixed-pitch propeller is made from a one-piece alloy forging.

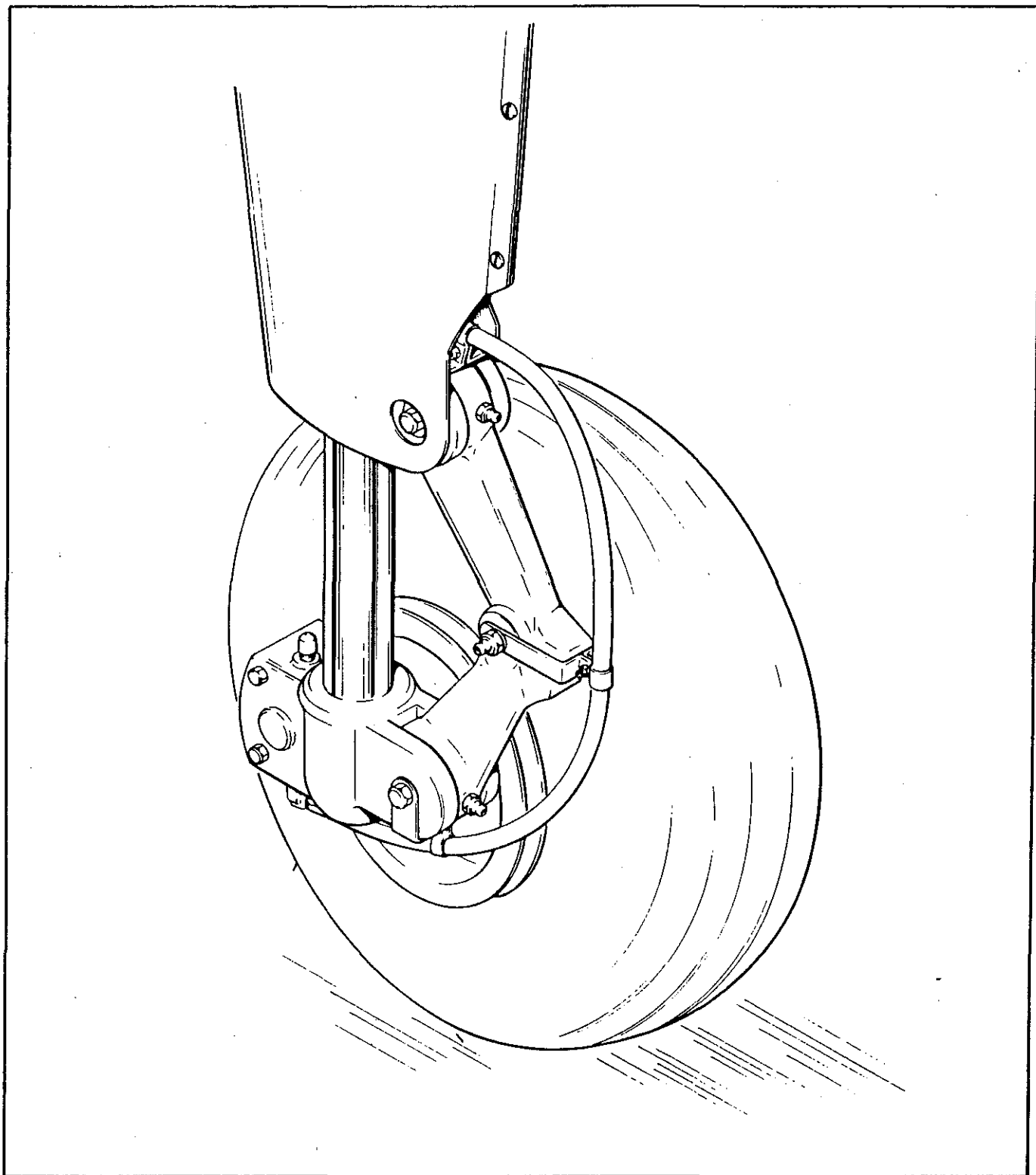

MAIN WHEEL ASSEMBLY

Figure 7-1

7.7 LANDING GEAR

The three landing gears use Cleveland 6.00 x 6 wheels, the main gear wheels (Figure 7-1) being provided with brake drums and Cleveland single disc hydraulic brake assemblies. All three wheels use 6.00 x 6, four-ply rating, Type III tires with tubes.

The nose gear is steerable through a 30 degree arc either side of center by use of the rudder pedals and brakes. A spring device incorporated in the rudder pedal torque tube assembly aids in rudder centering and provides rudder trim. The nose gear steering mechanism also incorporates a bungee assembly to reduce steering effort and to dampen shocks and bumps during taxiing. A shimmy dampener is included in the nose gear.

The three struts are of the air-oil type, with a normal extension of 3.25 inches for the nose gear and 4.50 inches for the main gear.

The standard brake system for this Cherokee consists of dual toe brakes attached to the rudder pedals and a hand lever and master cylinder located below and behind the left center of the instrument sub-panel. The toe brakes and the hand brake have their own brake cylinders, but they share a common reservoir. The brake fluid reservoir is installed on the top left front face of the fire wall. The parking brake is incorporated in the master cylinder and is actuated by pulling back on the brake lever, depressing the knob attached to the left side of the handle, and releasing the brake lever. To release the parking brake, pull back on the brake lever to disengage the catch mechanism and allow the handle to swing forward (refer to Figure 7-5).

THIS PAGE INTENTIONALLY LEFT BLANK

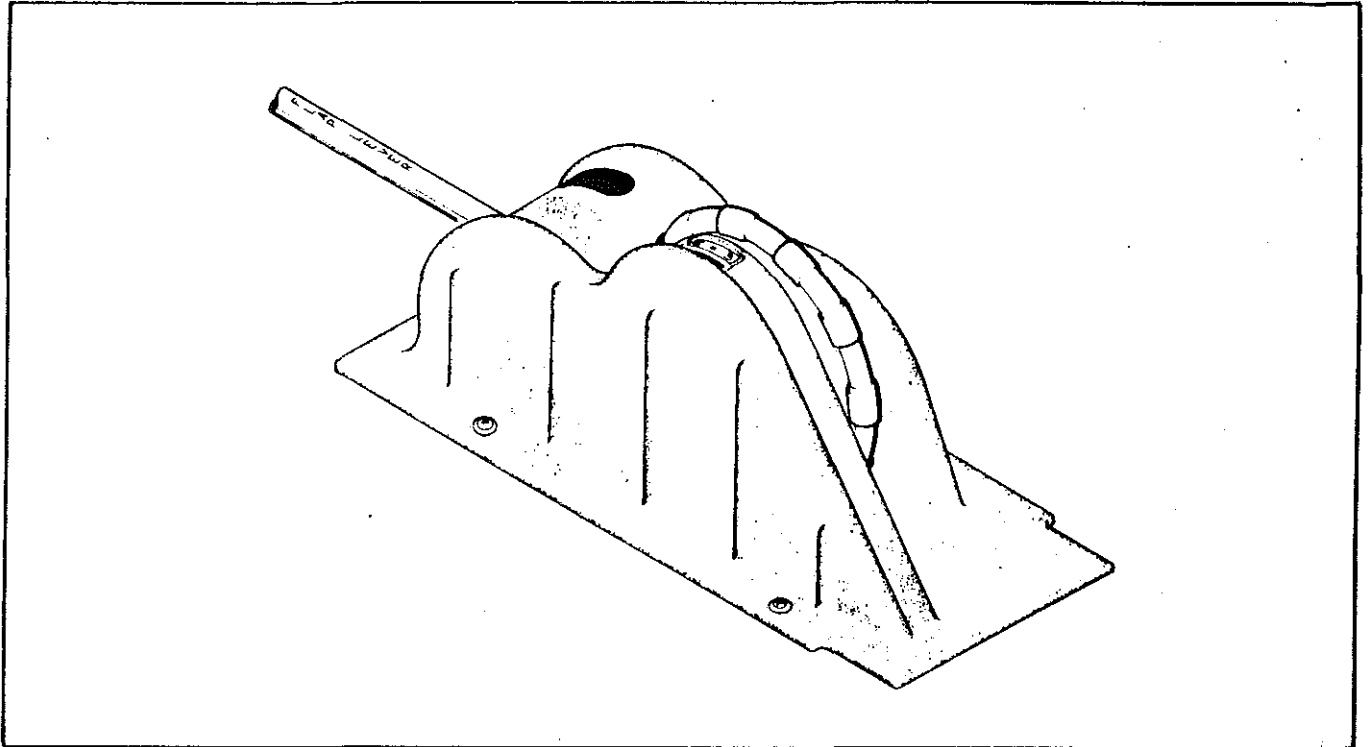

FLIGHT CONTROL CONSOLE

Figure 7-3

7.9 FLIGHT CONTROLS

Dual controls are provided as standard equipment, with a cable system used between the controls and the surfaces. The horizontal tail (stabilator) is of the all-movable slab type with a trim tab mounted on the trailing edge of the stabilator to reduce the control system forces. This tab is actuated by a control wheel on the floor between the front seats (Figure 7-3).

A rudder trim adjustment is mounted on the right side of the pedestal below the throttle quadrant and permits directional trim as needed in flight (refer to Figure 7-5).

The flaps are manually operated and spring-loaded to return to the up position. A past-center lock incorporated in the actuating linkage holds the flap when it is in the up position so that it may be used as a step on the right side. The flap will not support a step load except when in the full up position, so it must be completely retracted when used as a step. The flaps have three extended positions, 10, 25 and 40 degrees.

7.11 ENGINE CONTROLS

Engine controls consist of a throttle control and a mixture control lever. These controls are located on the control quadrant on the lower center of the instrument panel (Figure 7-5) where they are accessible to both the pilot and the copilot. The controls utilize teflon-lined control cables to reduce friction and binding.

The throttle lever is used to adjust engine RPM. The mixture control lever is used to adjust the air to fuel ratio. The engine is shut down by the placing of the mixture control lever in the full lean position. In addition, the mixture control has a lock to prevent inadvertent activation of the mixture control. For information on the leaning procedure, see the Avco-Lycoming Operator's Manual.

The friction adjustment lever on the right side of the control quadrant may be adjusted to increase or decrease the friction holding the throttle and mixture controls or to lock the controls in a selected position.

The carburetor heat control lever is located to the right of the control quadrant on the instrument panel. The control is placarded with two positions: "ON" (down), "OFF" (up).

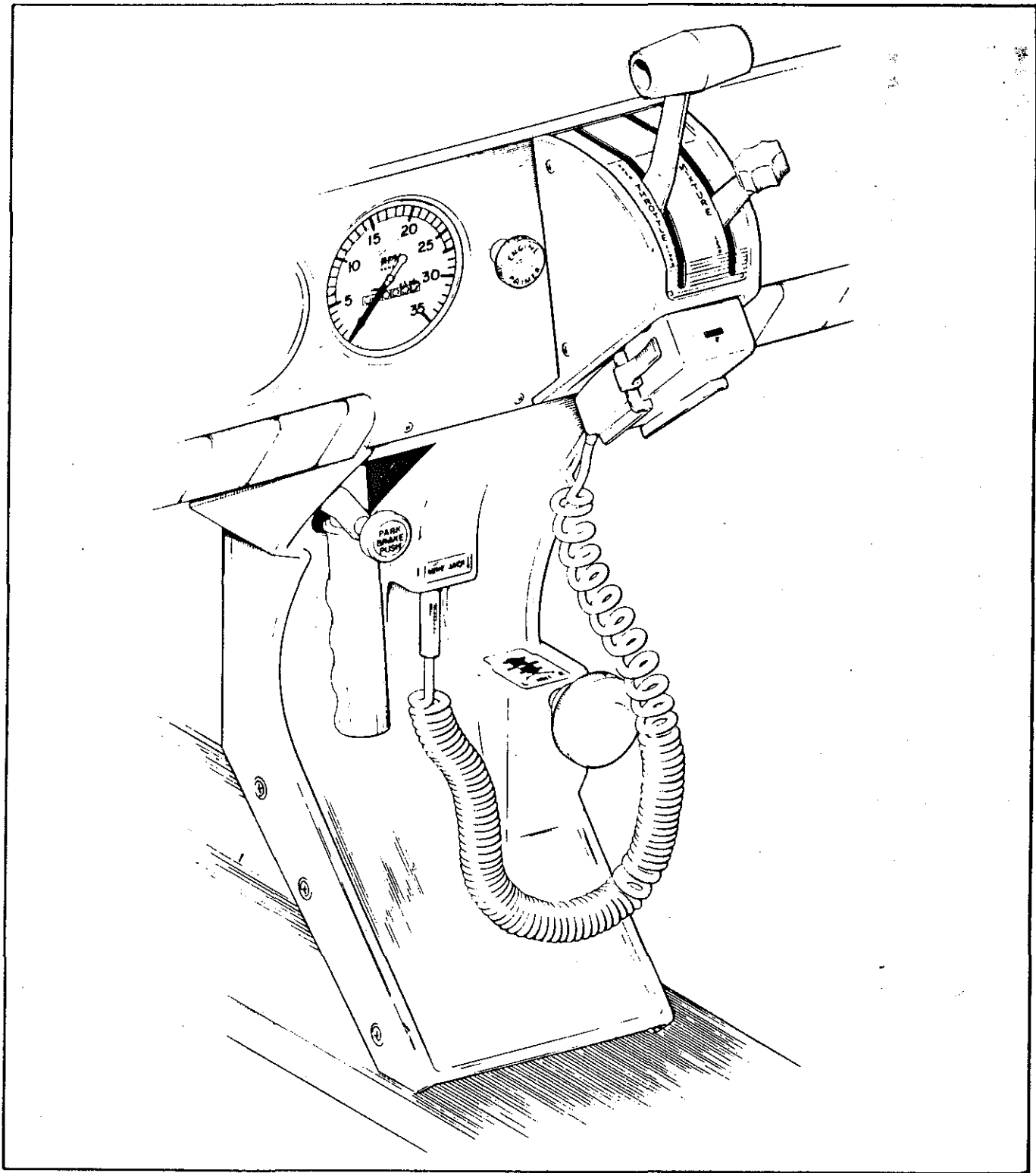

CONTROL QUADRANT AND CONSOLE

Figure 7-5

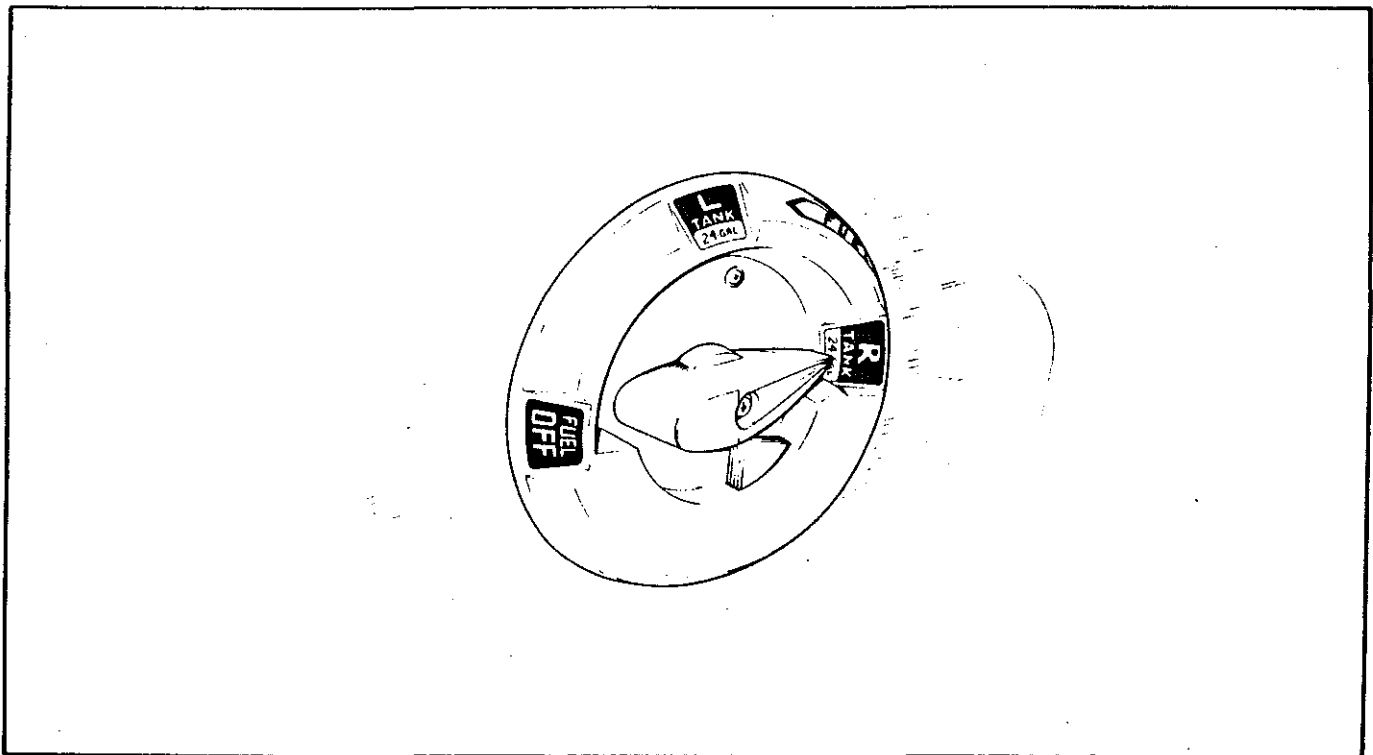

FUEL SELECTOR

Figure 7-7

7.13 FUEL SYSTEM

Fuel is stored in two twenty-five gallon (24 gallons usable) tanks which are secured to the leading edge structure of each wing by screws and nut plates.

The fuel selector control (Figure 7-7) is located on the left side-panel, forward of the pilot's seat. The button on the selector cover must be depressed and held while the handle is moved to the OFF position. The button releases automatically when the handle is moved back into the ON position.

An auxiliary electric fuel pump is provided in case of failure of the engine driven pump. The electric pump should be on for all takeoffs and landings, and when switching tanks. The pump switch is located in the switch panel above the throttle quadrant.

The fuel drains should be opened daily prior to first flight to check for water or sediment. Each tank has an individual drain at the bottom, inboard rear corner.

A fuel strainer, located on the lower left front of the fire wall, has a drain which is accessible from outside the nose section. The strainer should also be drained before the first flight of the day. Refer to paragraph 8.21 for the complete fuel draining procedure.

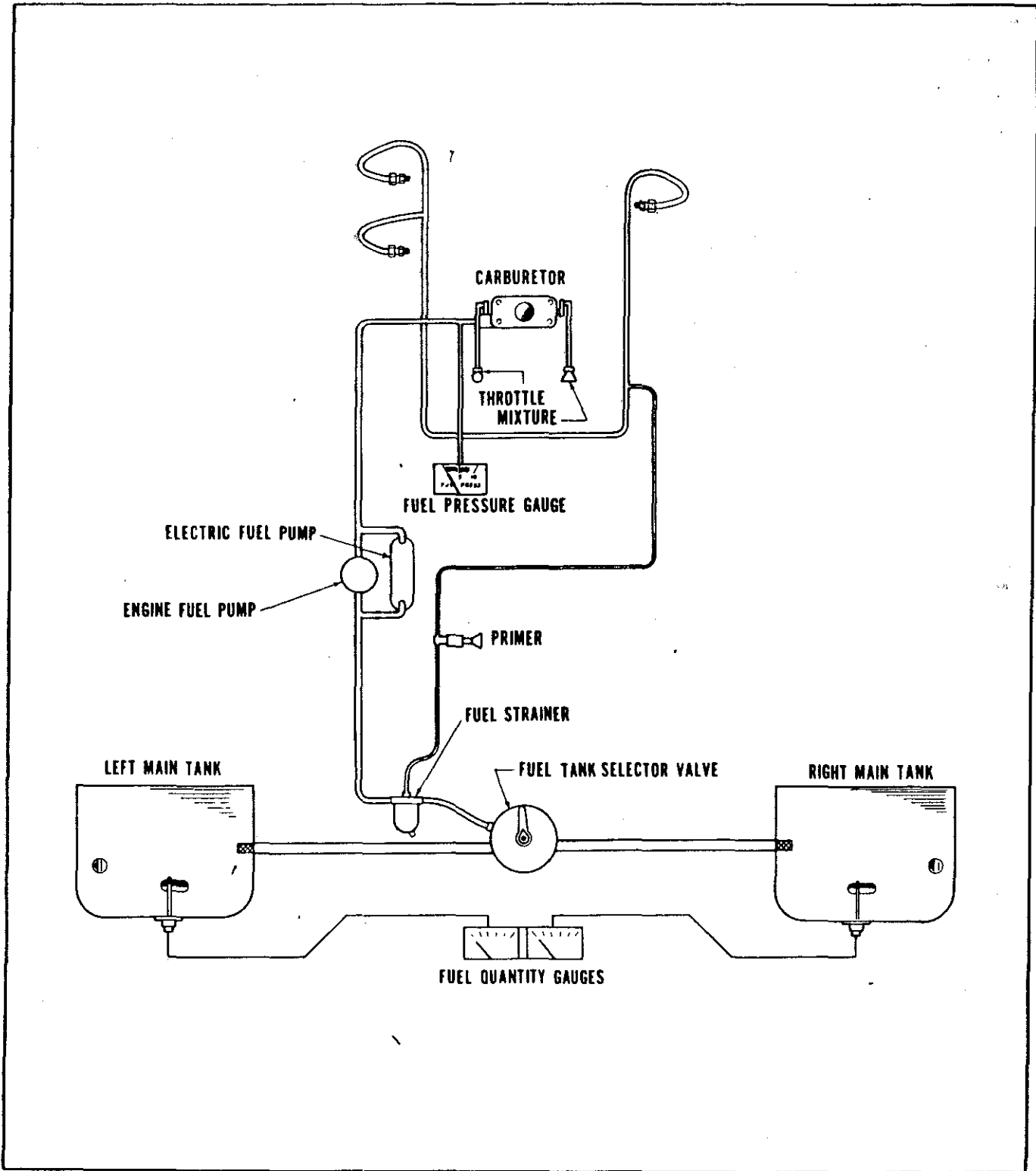

FUEL SYSTEM SCHEMATIC

Figure 7-9

Fuel quantity and pressure are indicated on gauges located in a cluster on the left side of the instrument panel.

An optional engine priming system is available to facilitate starting. The primer pump is located to the immediate left of the throttle quadrant (refer to Figure 7-5).

7.15 ELECTRICAL SYSTEM

The electrical system includes a 14-volt, 60 amp alternator, a 12-volt battery, a voltage regulator, an overvoltage relay and a master switch relay (Figure 7-11). The battery is mounted in a thermoplastic box immediately aft of the baggage compartment. The regulator and overvoltage relay are located on the forward left side of the fuselage behind the instrument panel.

Electrical switches are located on the right center instrument panel, and the circuit breakers are located on the lower right instrument panel. A rheostat switch on the left side of the switch panel controls the navigational lights and the radio lights. The similar switch on the right side controls and dims the panel lights.

Standard electrical accessories include a starter, electric fuel pump, stall warning indicator, cigar lighter, fuel gauge, ammeter, and annunciator panel.

The annunciator panel includes alternator and low oil pressure indicator lights. When the optional gyro system is installed, the annunciator panel also includes a low vacuum indicator light. The annunciator panel lights are provided only as a warning to the pilot that a system may not be operating properly, and that he should check and monitor the applicable system gauge to determine when or if any necessary action is required.

Optional electrical accessories include navigation lights, anti-collision light, landing light, instrument lighting, and cabin dome light. Circuits will handle the addition of communications and navigational equipment.

The words "master switch" used hereafter in this manual indicate both sides of the switch; battery side "BAT" and alternator side "ALT" are to be depressed simultaneously to OFF or ON as directed.

Unlike previous generator systems, the ammeter does not indicate battery discharge; rather it displays in amperes the load placed on the alternator. With all electrical equipment off (except master switch) the ammeter will be indicating the amount of charging current demanded by the battery. As each item of electrical equipment is turned on, the current will increase to a total appearing on the ammeter. This total includes the battery. The average continuous load for night flight, with radios on, is about 30 amperes. This 30 ampere value, plus approximately two amperes for a fully charged battery, will appear continuously under these flight conditions. The amount of current shown on the ammeter will tell immediately if the alternator system is operating normally, as the amount of current shown should equal the total amperage drawn by the equipment which is operating.

If no output is indicated on the ammeter during flight, reduce the electrical load by turning off all unnecessary electrical equipment. Check both 5 ampere field breaker and 60 ampere output breaker and reset if open. If neither circuit breaker is open, turn off the "ALT" switch for 1 second to reset the overvoltage relay. If ammeter continues to indicate no output, maintain minimum electrical load and terminate flight as soon as practical.

CAUTION

Do not use cigar lighter receptacles as power sources for any devices other than the cigar lighters supplied with the airplane. Any other device plugged into these receptacles may be damaged.

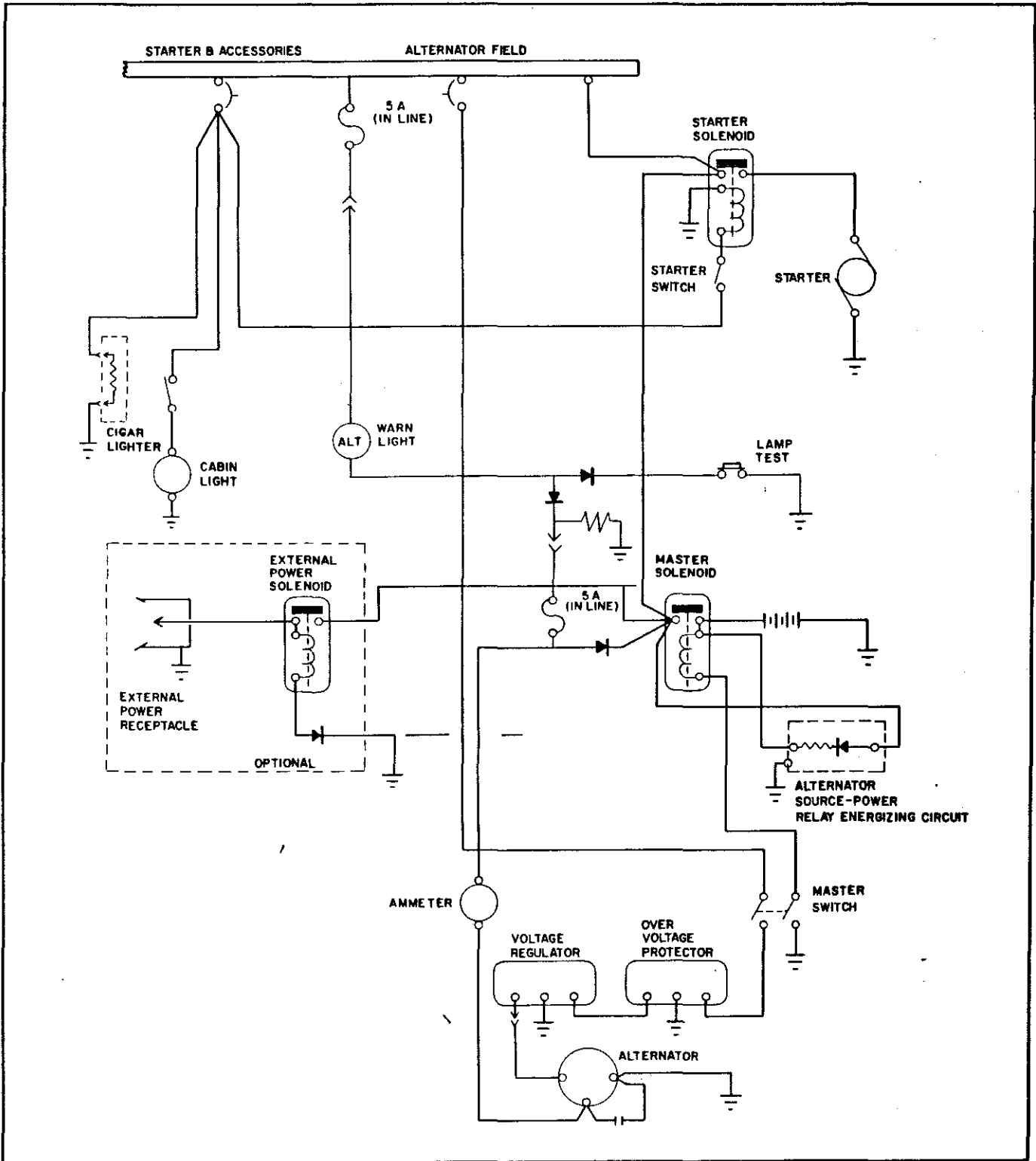

ALTERNATOR AND STARTER SCHEMATIC

Figure 7-11

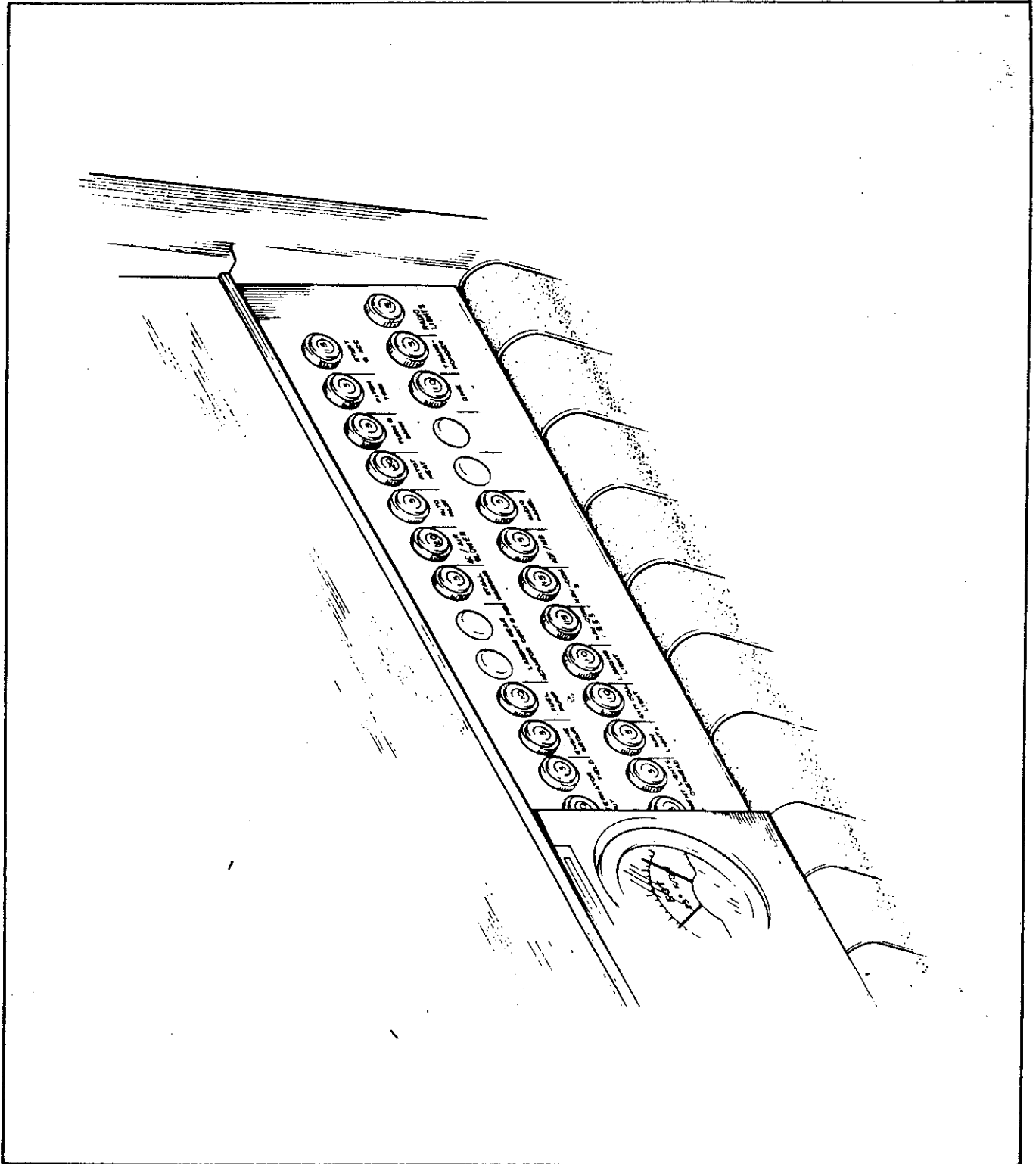

CIRCUIT BREAKER PANEL

Figure 7-13

THIS PAGE INTENTIONALLY LEFT BLANK

7.17 VACUUM SYSTEM

The vacuum system is designed to operate the air driven gyro instruments. This includes the directional and attitude gyros when installed. The system consists of an engine driven vacuum pump, a vacuum regulator, a filter and the necessary plumbing.

The vacuum pump is a dry type pump which eliminates the need for an air/oil separator and its plumbing. A shear drive protects the pump from damage. If the drive shears, the gyros will become inoperative.

The vacuum gauge, mounted on the right instrument panel to the right of the radios, provides valuable information to the pilot about the operation of the vacuum system. A decrease in pressure in a system that has remained constant over an extended period may indicate a dirty filter, dirty screens, possibly a sticking vacuum regulator or leak in system (a low vacuum indicator light is provided in the annunciator panel). Zero pressure would indicate a sheared pump drive, defective pump, possibly a defective gauge or collapsed line. In the event of any gauge variation from the norm, the pilot should have a mechanic check the system to prevent possible damage to the system components or eventual failure of the system.

A vacuum regulator is provided in the system to protect the gyros. The valve is set so the normal vacuum reads $5.0 \pm .1$ inches of mercury, a setting which provides sufficient vacuum to operate all the gyros at their rated RPM. Higher settings will damage the gyros and with a low setting the gyros will be unreliable. The regulator is located behind the instrument panel and is accessible from below the instrument panel.

7.19 INSTRUMENT PANEL

The instrument panel (Figure 7-15) of the Cherokee is designed to accommodate the customary advanced flight instruments and the normally required power plant instruments. The artificial horizon and directional gyro are vacuum operated through use of a vacuum pump installed on the engine, while the turn and bank instrument is electrically operated. A vacuum gauge is mounted on the far right side of the instrument panel. The radios and circuit breakers are on the right hand instrument panel. Extra circuits are provided for the addition of optional radio equipment. An annunciator panel is mounted in the upper instrument panel to warn the pilot of a possible malfunction in the alternator, oil pressure, or vacuum systems.

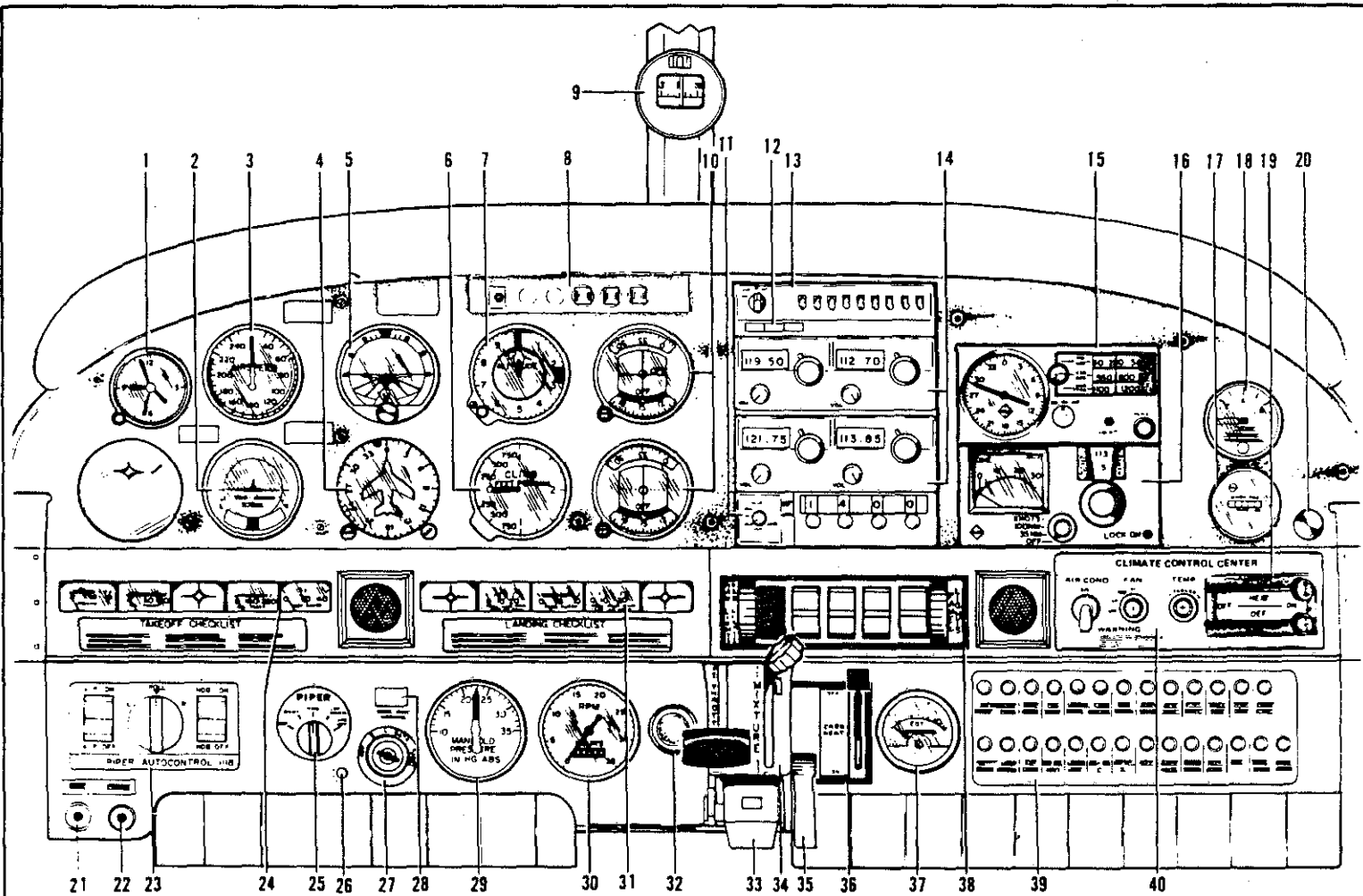

INSTRUMENT PANEL

Figure 7-15

- | | | |
|-----------------------------------|-------------------------------|-----------------------------|
| 1. CLOCK | 15. ADF RECEIVER | 29. MANIFOLD PRESSURE GAUGE |
| 2. TURN INDICATOR | 16. DME RECEIVER | 30. TACHOMETER |
| 3. AIRSPEED INDICATOR | 17. ENGINE HOUR METER | 31. FUEL GAUGES |
| 4. DIRECTIONAL GYRO | 18. SUCTION GAUGE | 32. PRIMER |
| 5. ATTITUDE GYRO | 19. HEAT & DEFROST CONTROL | 33. MICROPHONE |
| 6. VERTICAL SPEED INDICATOR | 20. CIGAR LIGHTER | 34. THROTTLE QUADRANT |
| 7. ALTIMETER | 21. MIKE JACK | 35. FRICTION LOCK |
| 8. ANNUNCIATOR PANEL | 22. PHONE JACK | 36. CARBURETOR HEAT CONTROL |
| 9. MAGNETIC COMPASS | 23. AUTOPILOT | 37. EGT INDICATOR |
| 10. OMNI & GLIDE SLOPE INDICATORS | 24. ENGINE INSTRUMENT CLUSTER | 38. INSTRUMENT PANEL LIGHTS |
| 11. TRANSPONDER | 25. OMNI COUPLER | 39. CIRCUIT BREAKER PANEL |
| 12. MARKER BEACON | 26. NAV SWITCH | 40. CLIMATE CONTROL |
| 13. AUDIO SELECTOR PANEL | 27. MAGNETO & STARTER SWITCH | |
| 14. VHF TRANSCEIVERS | 28. PITCH CONTROL | |

7.21 PITOT-STATIC SYSTEM

The system supplies both pitot and static pressure for the airspeed indicator, altimeter, and the optional vertical speed indicator (Figure 7-17).

Pitot and static pressure are picked up by a pitot head installed on the bottom of the left wing and carried through pitot and static lines within the wing and fuselage to the gauges on the instrument panel.

An alternate static source is available as optional equipment. The control valve is located below the left side of the instrument panel. When the valve is set in the alternate position, the altimeter, vertical speed indicator and airspeed indicator will be using cabin air for static pressure. The storm window and cabin vents must be closed and the cabin heater and defroster must be on during alternate static source operation. The altimeter error is less than 50 feet unless otherwise placarded.

Both the pitot and static lines can be drained through separate drain valves located on the left lower side of the fuselage interior.

A heated pitot head, which alleviates problems with icing and heavy rain, is available as optional equipment. The switch for the heated pitot head is located on the electrical switch panel to the left of the right control wheel.

To prevent bugs and water from entering the pitot and static pressure holes, a cover should be placed over the pitot head. A partially or completely blocked pitot head will give erratic or zero readings on the instruments.

NOTE

During the preflight, check to make sure the pitot cover is removed.

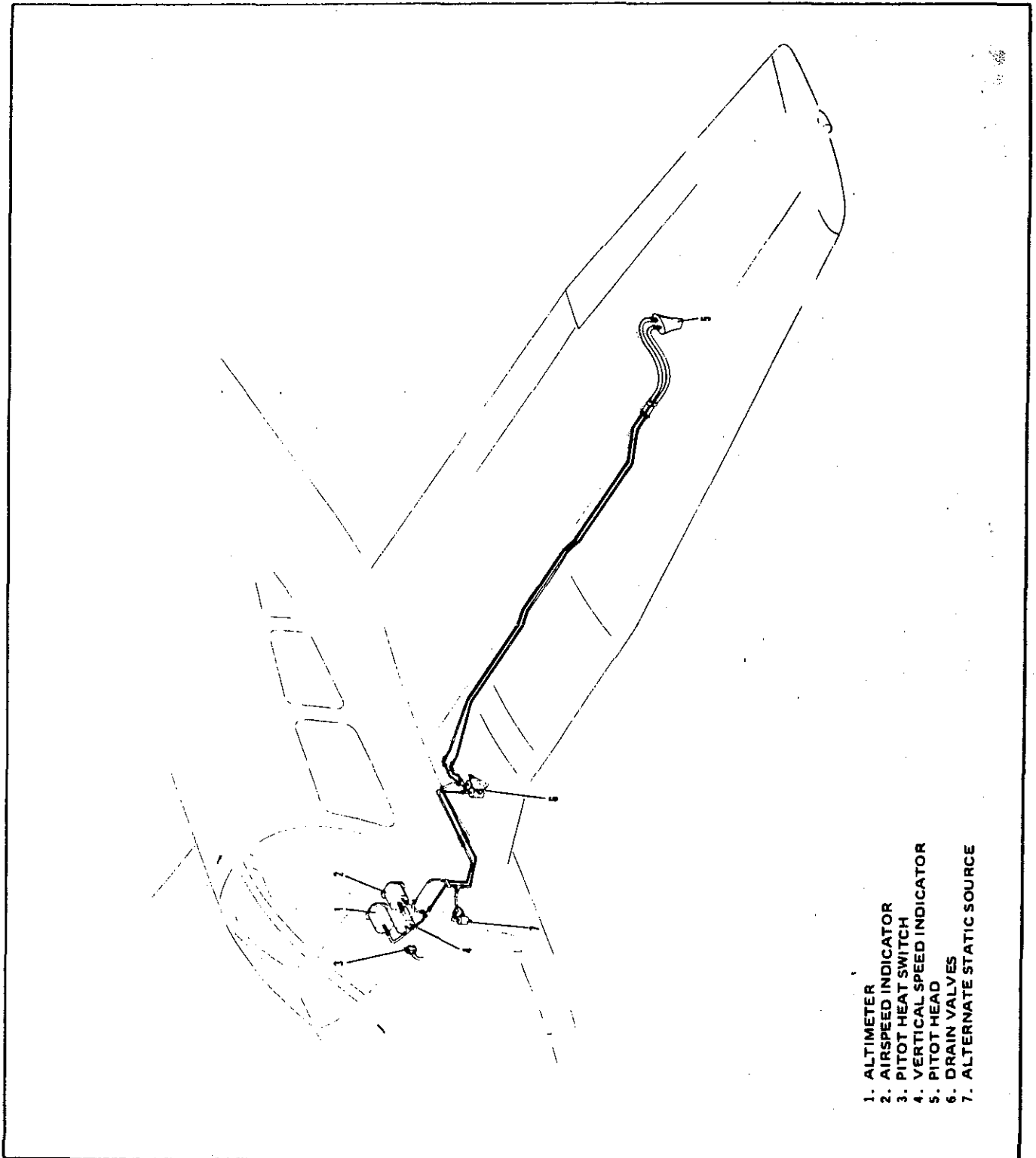

PITOT-STATIC SYSTEM

Figure 7-17

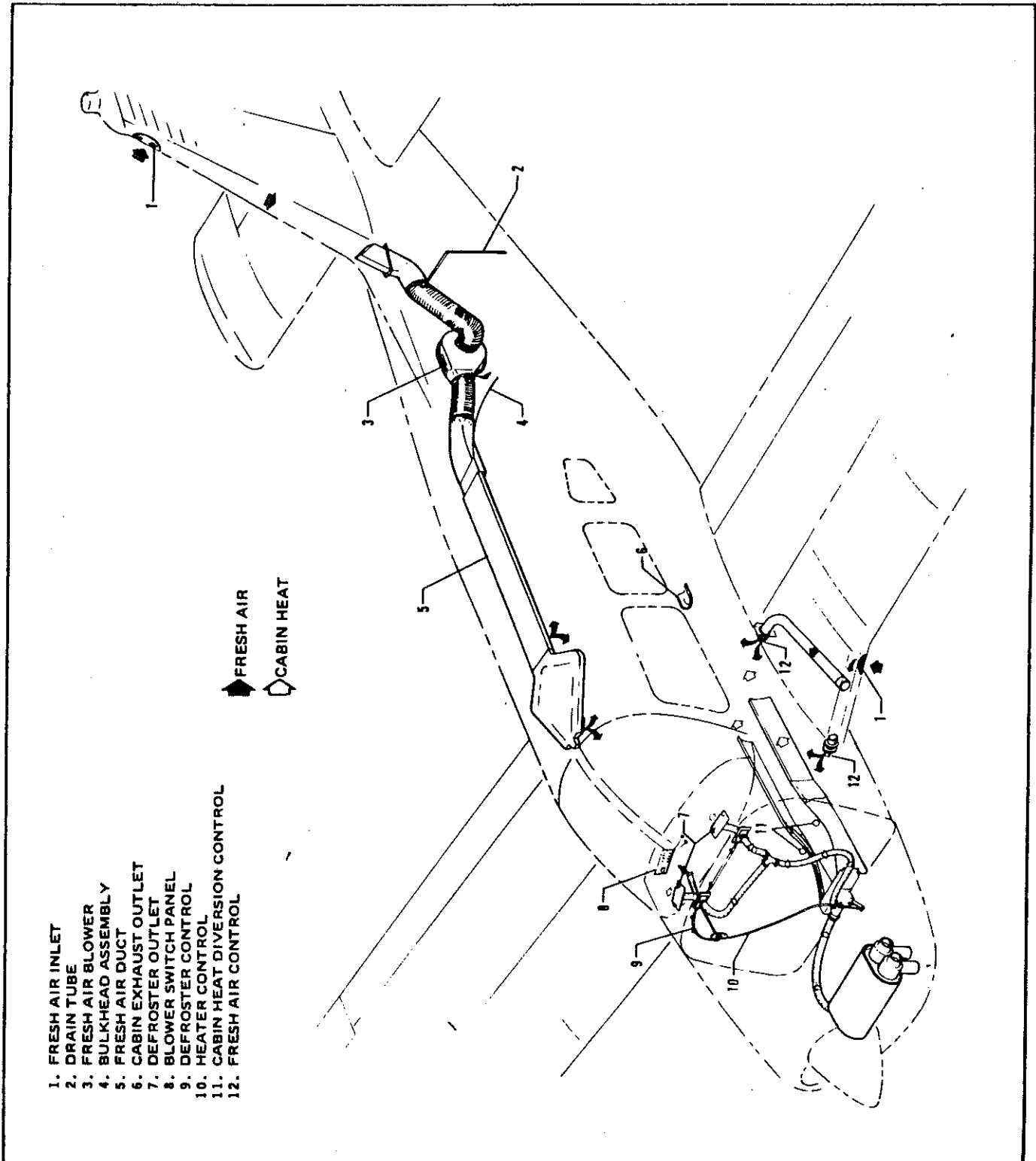

HEATING AND VENTILATING SYSTEM

Figure 7-19

7.23 HEATING AND VENTILATING SYSTEM

Heat for the cabin interior and the defroster system is provided by a heater muff attached to the exhaust system (Figure 7-19). The amount of heat desired can be regulated with the controls located on the far right side of the instrument panel.

The air flow can be regulated between the front and rear seats by levers located on top of the heat ducts next to the console.

Fresh air inlets are located in the leading edge of the wing near the fuselage. An adjustable outlet is located on the side of the cabin near the floor at each seat location; overhead air outlets are offered as optional equipment. Air is exhausted through an outlet under the rear seat. A cabin air blower, incorporated in the ventilating system, is also available as optional equipment. An optional overhead ventilating system with a cabin air blower is available on models without air conditioning. This blower is operated by a "FAN" switch with 4 positions - "OFF," "LOW," "MED," or "HIGH."

CAUTION

When cabin heat is operated, heat duct surface becomes hot. This could result in burns if arms or legs are placed too close to heat duct outlets or surface.

7.25 CABIN FEATURES

For ease of entry and exit and pilot-passenger comfort, the front seats are adjustable fore and aft. The rear seats may be removed to provide room for bulky items. Rear seat installations incorporate leg retainers with latching mechanisms which must be released before the rear seats can be removed. Releasing the retainers is accomplished on earlier models by turning the latching mechanisms 90° with a coin or screwdriver. Releasing the retainers is accomplished on later models by depressing the plunger behind each rear leg. Armrests are also provided for the front seats. All seats are available with optional headrests and optional vertical adjustment may be added to the front seats.

The cabin interior includes a pilot storm window, two sun visors, ash trays, two map pockets, and pockets on the backs of each front seat.

A single strap shoulder harness controlled by an inertia reel is standard equipment for the front seats, and is offered as an option for the rear seats. The shoulder strap is routed over the shoulder adjacent to the windows and attached to the lap belt in the general area of the person's inboard hip.

A check of the inertia reel mechanism is made by pulling sharply on the strap. The reel will lock in place under this test and prevent the strap from extending. Under normal movement the strap will extend and retract as required.

7.27 BAGGAGE AREA

A 24 cubic foot baggage area, located behind the rear seats, is accessible either from the cabin or through an outside baggage door on the right side of the aircraft. Maximum capacity is 200 pounds. Tie-down straps are provided and should be used at all times.

NOTE

It is the pilot's responsibility to be sure when the baggage is loaded that the aircraft C.G. falls within the allowable C.G. Range (refer to Section 6 - Weight and Balance).

7.29 STALL WARNING

An approaching stall is indicated by a stall warning horn which is activated between five and ten knots above stall speed. Mild airframe buffeting and gentle pitching may also precede the stall. Stall speeds are shown on graphs in the Performance Section. The stall warning horn emits a continuous sound and is activated by a lift detector installed on the leading edge of the left wing. During preflight, the stall warning system should be checked by turning the master switch "ON," lifting the detector and checking to determine if the horn is actuated.

7.31 FINISH

All exterior surfaces are primed with etching primer and finished with acrylic lacquer.

7.33 AIR CONDITIONING*

The air conditioning system is a recirculating air system. The major items include: evaporator, condenser, compressor, blower, switches and temperature controls.

The evaporator is located behind the left rear side of the baggage compartment. This cools the air that is used for air conditioning.

The condenser is mounted on a retractable scoop located on the bottom of the fuselage and to the rear of the baggage compartment area. The scoop extends when the air conditioner is "ON" and retracts to a flush position when the system is "OFF."

The compressor is mounted on the forward right underside of the engine. It has an electric clutch which automatically engages or disengages the compressor to the belt drive system of the compressor.

An electrical blower is mounted on the aft side of the rear cabin panel. Air from the baggage area is drawn through the evaporator by the blower and distributed through an overhead duct to individual outlets located adjacent to each occupant.

The switches and temperature control are located on the lower right side of the instrument panel in the climate control center panel. The temperature control regulates the desired temperature of the cabin. Turn the control clockwise for increased cooling, counterclockwise for decreased cooling.

Located inboard of the temperature control is the fan speed switch and the air conditioning "ON-OFF" switch. The fan can be operated independently of the air conditioning. However, it must be on for air conditioner operation. Turning either switch off will disengage the compressor clutch and retract the condenser door. Cooling air should be felt within one minute after the air conditioner is turned on.

NOTE

If the system is not operating in 5 minutes, turn the system "OFF" until the fault is corrected.

The "FAN" switch allows operation of the fan with the air conditioner turned "OFF" to aid cabin air circulation if desired. A "LOW," "MED" or "HIGH" flow of air can be selected to the air conditioner outlets located in the overhead duct. The outlets can be adjusted or turned off by each occupant to regulate individual cooling effect.

The "DOOR OPEN" indicator light is located to the left of the radio stack in front of the pilot. The light illuminates whenever the condenser door is open and remains on until the door is closed.

A circuit breaker located on the circuit breaker panel protects the air conditioning electrical system.

Whenever the throttle is in the full throttle position, it actuates a micro switch which disengages the compressor and retracts the scoop. This is done to obtain maximum power and maximum rate of climb. The fan continues to operate and the air will remain cool for approximately one minute. When the throttle is retarded approximately 1/4 inch, the clutch will engage and the scoop will extend, again supplying cool, dry air.

*Optional equipment

7.35 PIPER EXTERNAL POWER*

An optional starting installation known as Piper External Power (PEP) is accessible through a receptacle located on the right side of the fuselage aft of the wing. An external battery can be connected to the socket, thus allowing the operator to crank the engine without having to gain access to the airplane's battery.

7.37 EMERGENCY LOCATOR TRANSMITTER*

The Emergency Locator Transmitter (ELT) when installed, is located in the aft portion of the fuselage just below the stabilator leading edge and is accessible through a plate on the right side of the fuselage. This plate is attached with three slotted-head nylon screws for ease of removal; these screws may be readily removed with a variety of common items such as a dime, a key, a knife blade, etc. If there are no tools available in an emergency the screw heads may be broken off by any means. The ELT is an emergency locator transmitter which meets the requirements of FAR 91.52. It is automatically activated by a longitudinal force of 5 g's and transmits a distress signal on both 121.5 MHz and 243.0 MHz for a period of from 48 hours in low temperature areas up to 100 hours in high temperature areas. The unit operates on a self-contained battery.

The battery has a useful life of 10 years. However, to comply with FAA regulations it must be replaced after 5 years of shelf life or service life. The battery should also be replaced if the transmitter has been used in an emergency situation or if accumulated test time exceeds one hour. The replacement date is marked on the transmitter label.

On the unit itself is a three position selector switch placarded "OFF," "ARM" and "ON." The "ARM" position is provided to set the unit to the automatic position so that it will transmit only after impact and will continue to transmit until the battery is drained to depletion or until the switch is manually moved to the "OFF" position. The "ARM" position is selected when the transmitter is installed at the factory and the switch should remain in that position whenever the unit is installed in the airplane. The "ON" position is provided so the unit can be used as a portable transmitter or in the event the automatic feature was not triggered by impact or to periodically test the function of the transmitter.

Select the "OFF" position when changing the battery, when rearming the unit if it has been activated for any reason, or to discontinue transmission.

NOTE

If the switch has been placed in the "ON" position for any reason, the "OFF" position has to be selected before selecting "ARM." If "ARM" is selected directly from the "ON" position, the unit will continue to transmit in the "ARM" position.

*Optional equipment

A pilot's remote switch, located on the left side panel, is provided to allow the transmitter to be controlled from inside the cabin. The pilot's remote switch is placarded "ON, AUTO/ARM and OFF/RESET." The switch is normally left in the "AUTO/ARM" position. To turn the transmitter off, move the switch momentarily to the "OFF/RESET" position. The aircraft master switch must be "ON" to turn the transmitter "OFF." To actuate the transmitter for tests or other reasons, move the switch upward to the "ON" position and leave it in that position as long as transmission is desired.

The unit is equipped with a portable antenna to allow the locator to be removed from the airplane in case of an emergency and used as a portable signal transmitter.

The locator should be checked during the ground check to make certain the unit has not been accidentally activated. Check by tuning a radio receiver to 121.5 MHz. If there is an oscillating sound, the locator may have been activated and should be turned off immediately. Reset to the "ARM" position and check again to insure against outside interference.

NOTE

If for any reason a test transmission is necessary, the test transmission should be conducted only in the first five minutes of any hour and limited to three audio sweeps. If tests must be made at any other time, the tests should be coordinated with the nearest FAA tower or flight service station.

THIS PAGE INTENTIONALLY LEFT BLANK

TABLE OF CONTENTS

SECTION 8

AIRPLANE HANDLING, SERVICING AND MAINTENANCE

Paragraph No.		Page No.
8.1	General	8-1
8.3	Airplane Inspection Periods	8-3
8.5	Preventive Maintenance	8-4
8.7	Airplane Alterations	8-5
8.9	Ground Handling	8-6
8.11	Engine Air Filter	8-8
8.13	Brake Service	8-8
8.15	Landing Gear Service	8-10
8.17	Propeller Service	8-11
8.19	Oil Requirements	8-11
8.21	Fuel System	8-11
8.23	Tire Inflation	8-13
8.25	Battery Service	8-13
8.27	Cleaning	8-13

SECTION 8

AIRPLANE HANDLING, SERVICING AND MAINTENANCE

8.1 GENERAL

This section provides general guidelines relating to the handling, servicing and maintenance of the Archer II.

Every owner should stay in close contact with his Piper dealer or distributor and Authorized Piper Service Center to obtain the latest information pertaining to his aircraft and to avail himself of the Piper Aircraft Service Back-up.

Piper Aircraft Corporation takes a continuing interest in having the owner get the most efficient use from his aircraft and keeping it in the best mechanical condition. Consequently, Piper Aircraft from time to time issues Service Bulletins, Service Letters and Service Spares Letters relating to the aircraft.

Service Bulletins are of special importance and should be complied with promptly. These are sent to the latest registered owners, distributors and dealers. Depending on the nature of the bulletin, material and labor allowances may apply, and will be addressed in the body of the Bulletin.

Service Letters deal with product improvements and service hints pertaining to the aircraft. They are sent to dealers, distributors and occasionally (at the factory's discretion) to latest registered owners, so they can properly service the aircraft and keep it up to date with the latest changes. Owners should give careful attention to the Service Letter information.

Service Spares Letters offer improved parts, kits and optional equipment which were not available originally and which may be of interest to the owner.

If an owner is not having his aircraft serviced by an Authorized Piper Service Center, he should periodically check with a Piper dealer or distributor to find out the latest information to keep his aircraft up to date.

Piper Aircraft Corporation has a Subscription Service for the Service Bulletins, Service Letters and Service Spares Letters. This service is offered to interested persons such as owners, pilots and mechanics at a nominal fee, and may be obtained through Piper dealers and distributors.

A service manual, parts catalog, and revisions to both, are available from your Piper dealer or distributor. Any correspondence regarding the airplane should include the airplane model and serial number to insure proper response.

THIS PAGE INTENTIONALLY LEFT BLANK

8.3 AIRPLANE INSPECTION PERIODS

The Federal Aviation Administration (FAA) occasionally publishes Airworthiness Directives (ADs) that apply to specific groups of aircraft. They are mandatory changes and are to be complied with within a time limit set by the FAA. When an AD is issued, it is sent by the FAA to the latest registered owner of the affected aircraft and also to subscribers of their service. The owner should periodically check with his Piper dealer or A & P mechanic to see whether he has the latest issued AD against his aircraft.

The Owner Service Agreement which the owner receives upon delivery of the aircraft should be kept in the aircraft at all times. This identifies him to authorized Piper dealers and entitles the owner to receive service in accordance with the regular service agreement terms. This agreement also entitles the transient owner full warranty by any Piper dealer in the world.

One hundred hour inspections are required by law if the aircraft is used commercially. Otherwise this inspection is left to the discretion of the owner. This inspection is a complete check of the aircraft and its systems, and should be accomplished by a Piper Authorized Service Center or by a qualified aircraft and power plant mechanic who owns or works for a reputable repair shop. The inspection is listed, in detail, in the inspection report of the appropriate Service Manual.

An annual inspection is required once a year to keep the Airworthiness Certificate in effect. It is the same as a 100-hour inspection except that it must be signed by an Inspection Authorized (IA) mechanic or a General Aviation District Office (GADO) representative. This inspection is required whether the aircraft is operated commercially or for pleasure.

A Progressive Maintenance program is approved by the FAA and is available to the owner. It involves routine and detailed inspections at 50-hour intervals. The purpose of the program is to allow maximum utilization of the aircraft, to reduce maintenance inspection cost and to maintain a maximum standard of continuous airworthiness. Complete details are available from Piper dealers.

A spectographic analysis of the oil is available from several sources. This system, if used intelligently, provides a good check of the internal condition of the engine. For this system to be accurate, oil samples must be sent in at regular intervals, and induction air filters must be cleaned or changed regularly.

8.5 PREVENTIVE MAINTENANCE

The holder of a Pilot Certificate issued under FAR Part 61 may perform certain preventive maintenance described in FAR Part 43. This maintenance may be performed only on an aircraft which the pilot owns or operates and which is not used to carry persons or property for hire, except as provided in applicable FAR's. Although such maintenance is allowed by law, each individual should make a self-analysis as to whether he has the ability to perform the work.

All other maintenance required on the airplane should be accomplished by appropriately licensed personnel.

If maintenance is accomplished, an entry must be made in the appropriate logbook. The entry should contain:

1. The date the work was accomplished.
2. Description of the work.
3. Number of hours on the aircraft.
4. The certificate number of pilot performing the work.
5. Signature of the individual doing the work.

8.7 AIRPLANE ALTERATIONS

If the owner desires to have his aircraft modified, he must obtain FAA approval for the alteration. Major alterations accomplished in accordance with Advisory Circular 43.13-2, when performed by an A & P mechanic, may be approved by the local FAA office. Major alterations to the basic airframe or systems not covered by AC 43.13-2 require a Supplemental Type Certificate.

The owner or pilot is required to ascertain that the following Aircraft Papers are in order and in the aircraft.

- (a) To be displayed in the aircraft at all times:
 - (1) Aircraft Airworthiness Certificate Form FAA-8100-2.
 - (2) Aircraft Registration Certificate Form FAA-8050-3.
 - (3) Aircraft Radio Station License if transmitters are installed.

- (b) To be carried in the aircraft at all times:
 - (1) Pilot's Operating Handbook.
 - (2) Weight and Balance data plus a copy of the latest Repair and Alteration Form FAA-337, if applicable.
 - (3) Aircraft equipment list.

Although the aircraft and engine logbooks are not required to be in the aircraft, they should be made available upon request. Logbooks should be complete and up to date. Good records will reduce maintenance cost by giving the mechanic information about what has or has not been accomplished.

3.9 GROUND HANDLING

(a) Towing

The airplane may be moved on the ground by the use of the nose wheel steering bar that is stowed below the forward ledge of the baggage compartment or by power equipment that will not damage or excessively strain the nose gear steering assembly. Towing lugs are incorporated as part of the nose gear fork.

CAUTION

When towing with power equipment, do not turn the nose gear beyond its steering radius in either direction, as this will result in damage to the nose gear and steering mechanism.

CAUTION

Do not tow the airplane when the controls are secured.

In the event towing lines are necessary, ropes should be attached to both main gear struts as high up on the tubes as possible. Lines should be long enough to clear the nose and/or tail by not less than fifteen feet, and a qualified person should ride in the pilot's seat to maintain control by use of the brakes.

(b) Taxiing

Before attempting to taxi the airplane, ground personnel should be instructed and approved by a qualified person authorized by the owner. Engine starting and shut-down procedures as well as taxi techniques should be covered. When it is ascertained that the propeller back blast and taxi areas are clear, power should be applied to start the taxi roll, and the following checks should be performed:

- (1) Taxi a few feet forward and apply the brakes to determine their effectiveness.
- (2) While taxiing, make slight turns to ascertain the effectiveness of the steering.
- (3) Observe wing clearance when taxiing near buildings or other stationary objects. If possible, station an observer outside the airplane.
- (4) When taxiing over uneven ground, avoid holes and ruts.
- (5) Do not operate the engine at high RPM when running up or taxiing over ground containing loose stones, gravel, or any loose material that may cause damage to the propeller blades.

(c) Parking

When parking the airplane, be sure that it is sufficiently protected from adverse weather conditions and that it presents no danger to other aircraft. When parking the airplane for any length of time or overnight, it is suggested that it be moored securely.

- (1) To park the airplane, head it into the wind if possible.
- (2) Set the parking brake by pulling back on the brake lever and depressing the knob on the handle. To release the parking brake, pull back on the handle until the catch disengages; then allow the handle to swing forward.

CAUTION

Care should be taken when setting brakes that are overheated or during cold weather when accumulated moisture may freeze a brake.

- (3) Aileron and stabilator controls should be secured with the front seat belt and chocks used to properly block the wheels.

(d) Mooring

The airplane should be moored for immovability, security and protection. The following procedures should be used for the proper mooring of the airplane:

- (1) Head the airplane into the wind if possible.
- (2) Retract the flaps.
- (3) Immobilize the ailerons and stabilator by looping the seat belt through the control wheel and pulling it snug.
- (4) Block the wheels.
- (5) Secure tie-down ropes to the wing tie-down rings and to the tail skid at approximately 45 degree angles to the ground. When using rope of non-synthetic material, leave sufficient slack to avoid damage to the airplane should the ropes contract.

CAUTION

Use bowline knots, square knots or locked slip knots. Do not use plain slip knots.

NOTE

Additional preparations for high winds include using tie-down ropes from the landing gear forks and securing the rudder.

- (6) Install a pitot head cover if available. Be sure to remove the pitot head cover before flight.
- (7) Cabin and baggage doors should be locked when the airplane is unattended.

8.11 ENGINE AIR FILTER

(a) Removing Engine Air Filter

- (1) Remove the lower cowl.
- (2) Remove the wing nuts securing the filter. Remove the filter.

(b) Cleaning Engine Air Filter

The induction air filter must be cleaned at least once every 50 hours, and more often, even daily, when operating in dusty conditions. Extra filters are inexpensive, and a spare should be kept on hand for use as a rapid replacement.

To clean the filter:

- (1) Tap the filter gently to remove dirt particles, being careful not to damage the filter. DO NOT wash the filter in any liquid. DO NOT attempt to blow out dirt with compressed air.
- (2) If the filter is excessively dirty or shows any damage, replace it immediately.
- (3) Wipe the filter housing with a clean cloth and install the filter. The usable life of the filter should be restricted to one year or 500 hours, whichever comes first.

(c) Installation Of Engine Air Filter

After cleaning or when replacing the filter, install the filter in the reverse order of removal.

8.13 BRAKE SERVICE

The brake system is filled with MIL-H-5606 (petroleum base) hydraulic brake fluid. The fluid level should be checked periodically or at every 50 hour inspection and replenished when necessary. The brake reservoir is located on the fire wall in the engine compartment. If the entire system must be refilled, fill with fluid under pressure from the brake end of the system. This will eliminate air from the system.

No adjustment of the brake clearances is necessary. If after extended service brake blocks become excessively worn, they should be replaced with new segments.

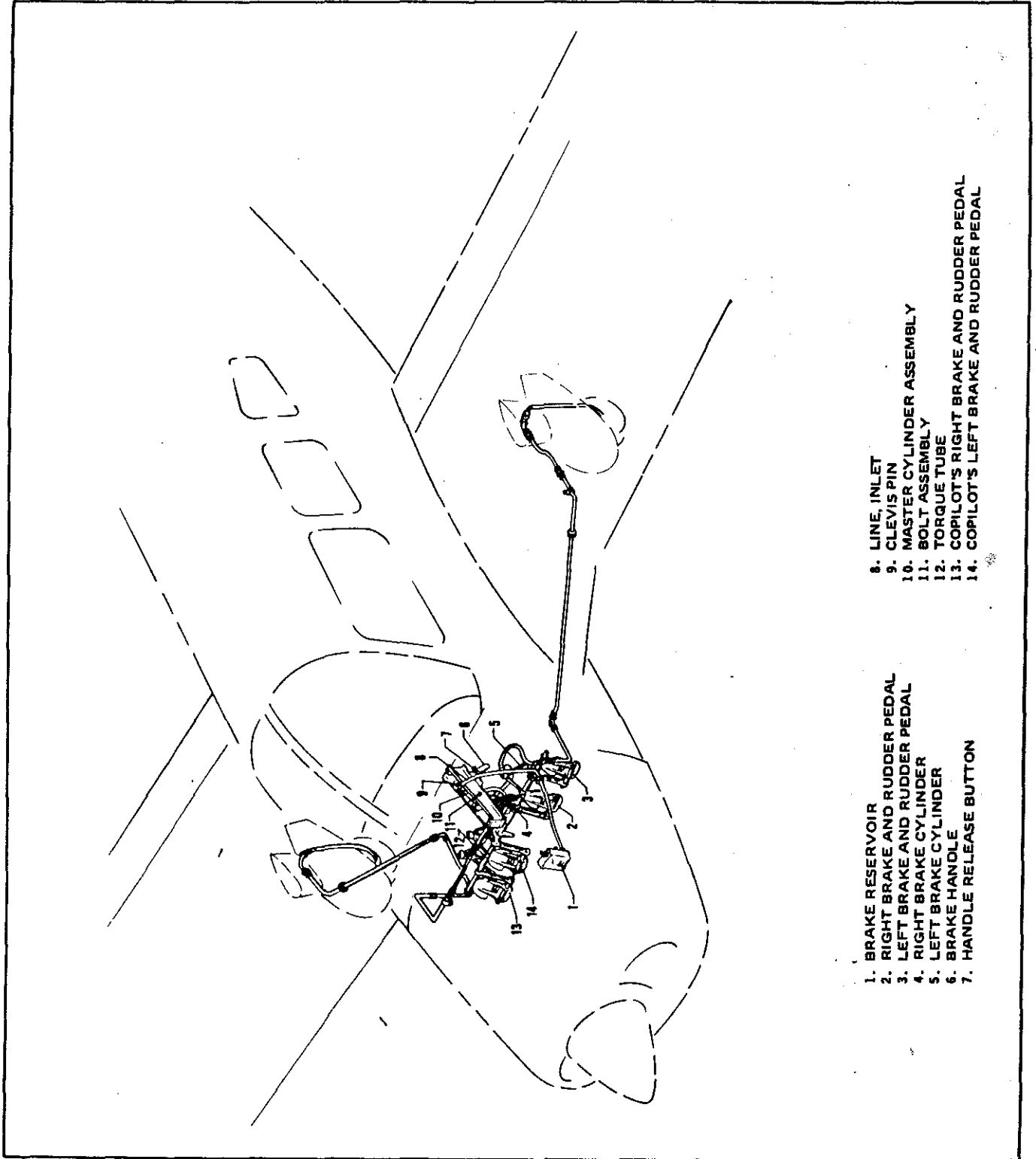

- 8. LINE, INLET
- 9. CLEVIS PIN
- 10. MASTER CYLINDER ASSEMBLY
- 11. BOLT ASSEMBLY
- 12. TORQUE TUBE
- 13. COPILOT'S RIGHT BRAKE AND RUDDER PEDAL
- 14. COPILOT'S LEFT BRAKE AND RUDDER PEDAL

- 1. BRAKE RESERVOIR
- 2. RIGHT BRAKE AND RUDDER PEDAL
- 3. LEFT BRAKE AND RUDDER PEDAL
- 4. RIGHT BRAKE CYLINDER
- 5. LEFT BRAKE CYLINDER
- 6. BRAKE HANDLE
- 7. HANDLE RELEASE BUTTON

BRAKE SYSTEM

Figure 8-1

8.15 LANDING GEAR SERVICE

The three landing gears use Cleveland Aircraft Products 6.00 x 6, four-ply rating, type III tires and tubes. (Refer to paragraph 8.23.)

Wheels are removed by taking off the hub cap, cotter pin, axle nut, and the two bolts holding the brake segment in place. Mark tire and wheel for reinstallation; then dismount by deflating the tire, removing the three through-bolts from the wheel and separating the wheel halves.

Landing gear oleos on the Cherokee Archer II should be serviced according to the instructions on the units. The main oleos should be extended under normal static load until $4.50 \pm .25$ inches of oleo piston tube is exposed, and the nose gear should show $3.25 \pm .25$ inches. Should the strut exposure be below that required, it should be determined whether air or oil is required by first raising the airplane on jacks. Depress the valve core to allow air to escape from the strut housing chamber. Remove the filler plug and slowly raise the strut to full compression. If the strut has sufficient fluid, it will be visible up to the bottom of the filler plug hole and will then require only proper inflation.

Should fluid be below the bottom of the filler plug hole, oil should be added. Replace the plug with valve core removed; attach a clear plastic hose to the valve stem of the filler plug and submerge the other end in a container of hydraulic fluid. Fully compress and extend the strut several times, thus drawing fluid from the container and expelling air from the strut chamber. To allow fluid to enter the bottom chamber of the main gear strut housing, the torque link assembly must be disconnected to let the strut be extended a minimum of 10 inches (the nose gear torque links need not be disconnected). Do not allow the strut to extend more than 12 inches. When air bubbles cease to flow through the hose, compress the strut fully and again check fluid level. Reinstall the valve core and filler plug, and the main gear torque links, if disconnected.

With fluid in the strut housing at the correct level, attach a strut pump to the air valve and with the airplane on the ground, inflate the oleo strut to the correct height.

In jacking the aircraft for landing gear or other service, two hydraulic jacks and a tail stand should be used. At least 250 pounds of ballast should be placed on the base of the tail stand before the airplane is jacked up. The hydraulic jacks should be placed under the jack points on the bottom of the wing and the airplane jacked up until the tail skid is at the right height to attach the tail stand. After the tail stand is attached and the ballast added, jacking may be continued until the airplane is at the height desired.

The steering arms from the rudder pedals to the nose wheel are adjusted at the nose wheel by turning the threaded rod end bearings in or out. Adjustment is normally accomplished at the forward end of the rods and should be done in such a way that the nose wheel is in line with the fore and aft axis of the plane when the rudder pedals and rudder are centered. Alignment of the nose wheel can be checked by pushing the airplane back and forth with the rudder centered to determine that the plane follows a perfectly straight line. The turning arc of the nose wheel is $30.0^\circ \pm 2^\circ$ in either direction and is limited by stops on the bottom of the forging.

The rudder pedal arm stops should be carefully adjusted so that the pedal arms contact the stops just after the rudder hits its stops. This guarantees that the rudder will be allowed to move through its full travel.

8.17 PROPELLER SERVICE

The spinner and backing plate should be frequently cleaned and inspected for cracks. Before each flight the propeller should be inspected for nicks, scratches, and corrosion. If found, they should be repaired as soon as possible by a rated mechanic, since a nick or scratch causes an area of increased stress which can lead to serious cracks or the loss of a propeller tip. The back face of the blades should be painted when necessary with flat black paint to retard glare. To prevent corrosion, the surface should be cleaned and waxed periodically.

8.19 OIL REQUIREMENTS

The oil capacity of the engine is 8 quarts and the minimum safe quantity is 2 quarts. It is recommended that the oil filter element be changed every 50 hours or sooner under unfavorable conditions. Engine oil is normally changed with the filter. However, if the full flow (cartridge type) oil filter is used and changed every 50 hours of operation, the intervals between oil changes may be increased as much as 100 percent. The following grades are recommended for the specified temperatures:

Average Ambient Air Temperature For Starting	Single Viscosity Grade	Multi-Viscosity Grades
Above 60°F	SAE 50	SAE 40 or SAE 50
30° to 90°F	SAE 40	SAE 40
0° to 70°F	SAE 30	SAE 40 or 20W-30
Below 10°F	SAE 20	SAE 20W-30

8.21 FUEL SYSTEM

(a) Servicing Fuel System

Refer to the PA-28 Cherokee Service Manual and Periodic Inspection Report for fuel system servicing and inspection.

(b) Fuel Requirements (AVGAS ONLY)

Aviation grade fuel with a minimum octane of 100/130 is specified for use in this airplane. Since the use of lower grades can cause serious damage in a short period of time, the engine warranty is invalidated by the use of lower octanes. Refer to the latest issue of Lycoming Service Instruction No. 1070 for alternate fuels and additional information.

A summary of the current grades as well as the previous fuel designations is shown in the following chart:

FUEL GRADE COMPARISON CHART

Previous Commercial Fuel Grades (ASTM-D910)			Current Commercial Fuel Grades (ASTM-D910-75)			Current Military Fuel Grades (MIL-G-5572E) Amendment No. 3		
Grade	Color	Max. TEL ml/U.S. gal.	Grade	Color	Max. TEL ml/U.S. gal.	Grade	Color	Max. TEL ml/U.S. gal.
80/87	red	0.5	80	red	0.5	80/87	red	0.5
91/98	blue	2.0	*100LL	blue	2.0	none	none	none
100/130	green	3.0	100	green	**3.0	100/130	green	**3.0
115/145	purple	4.6	none	none	none	115/145	purple	4.6

* - Grade 100LL fuel in some overseas countries is currently colored green and designated as "100L."

** - Commercial fuel grade 100 and grade 100/130 (both of which are colored green) having TEL content of up to 4 ml/U.S. gallon are approved for use in all engines certificated for use with grade 100/130 fuel.

The operation of the aircraft is approved with an anti-icing additive in the fuel. When an anti-icing additive is used it must meet the specification MIL-I-27686, must be uniformly blended with the fuel while refueling, must not exceed .15% by volume of the refueled quantity, and to ensure its effectiveness should be blended at not less than .10% by volume. One and one half liquid ozs. per ten gallon of fuel would fall within this range. A blender supplied by the additive manufacturer should be used. Except for the information contained in this section, the manufacturer's mixing or blending instructions should be carefully followed.

CAUTIONS

Assure that the additive is directed into the flowing fuel stream. The additive flow should start after and stop before the fuel flow. Do not permit the concentrated additive to come in contact with the aircraft painted surfaces or the interior surfaces of the fuel tanks.

Some fuels have anti-icing additives preblended in the fuel at the refinery, so no further blending should be performed.

(c) Filling Fuel Tanks

Observe all required precautions for handling gasoline. Fuel is stored in two twenty-five gallon (24 gal. usable) tanks.

There is approximately 17 gallons in the fuel tank when fuel level is even with bottom of filler neck indicator.

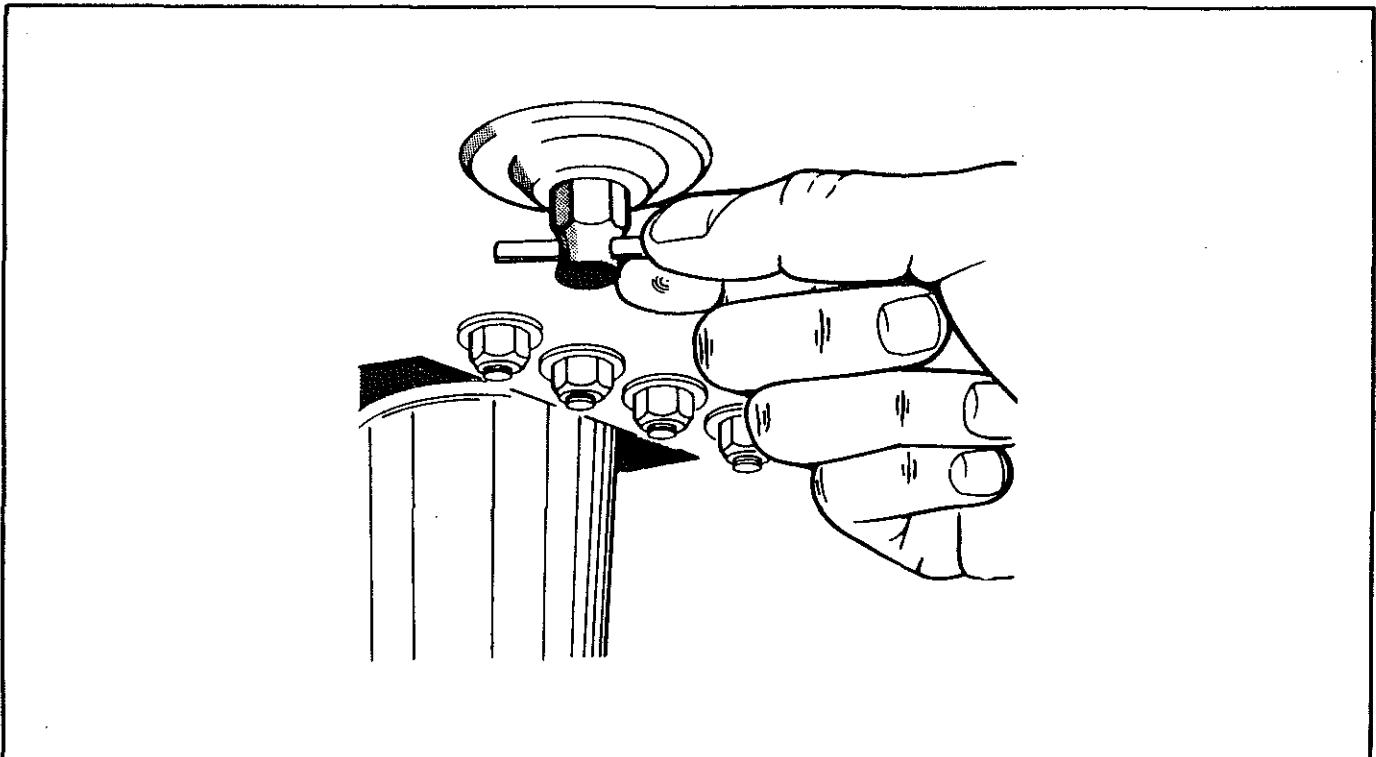

FUEL DRAIN

Figure 8-3

(d) Draining Fuel Strainer, Sumps and Lines

The fuel system sumps and strainer should be drained daily prior to the first flight and after refueling to avoid the accumulation of contaminants such as water or sediment. Each fuel tank is equipped with an individual quick drain located at the lower inboard rear corner of the tank. The fuel strainer is equipped with a quick drain located on the front lower corner of the firewall. Each of the fuel tank sumps should be drained first. Then the fuel strainer should be drained twice, once with the fuel selector valve on each tank. Each time fuel is drained, sufficient fuel should be allowed to flow to ensure removal of contaminants. This fuel should be collected in a suitable container, examined for contaminants, and then discarded.

CAUTION

When draining any amount of fuel, care should be taken to ensure that no fire hazard exists before starting the engine.

Each quick drain should be checked after closing it to make sure it has closed completely and is not leaking.

(e) Draining Fuel System

The bulk of the fuel may be drained from the system by opening the valve at the inboard end of each fuel tank. Push up on the arms of the drain valve and turn counterclockwise to hold the drain open. The remaining fuel in the system may be drained through the filter bowl. Any individual tank may be drained by closing the selector valve and then draining the desired tank.

8.23 TIRE INFLATION

For maximum service from the tires, keep them inflated to the proper pressures - 18 psi for the nose gear and 24 psi for the main gear. All wheels and tires are balanced before original installation, and the relationship of tire, tube and wheel should be maintained upon reinstallation. Unbalanced wheels can cause extreme vibration in the landing gear; therefore, in the installation of new components, it may be necessary to rebalance the wheels with the tires mounted. When checking tire pressure, examine the tires for wear, cuts, bruises, and slippage.

8.25 BATTERY SERVICE

Access to the 12-volt battery is through an access panel at the right rear side of the baggage compartment. The battery box has a plastic tube which is normally closed off with a cap and which should be opened occasionally to drain off any accumulation of liquid. The battery should be checked for proper fluid level. DO NOT fill the battery above the baffle plates. DO NOT fill the battery with acid - use water only. A hydrometer check will determine the percent of charge in the battery.

If the battery is not up to charge, recharge starting at a 4 amp rate and finishing with a 2 amp rate. Quick charges are not recommended.

8.27 CLEANING

(a) Cleaning Engine Compartment

Before cleaning the engine compartment, place a strip of tape on the magneto vents to prevent any solvent from entering these units.

- (1) Place a large pan under the engine to catch waste.
- (2) With the engine cowling removed, spray or brush the engine with solvent or a mixture of solvent and degreaser. In order to remove especially heavy dirt and grease deposits, it may be necessary to brush areas that were sprayed.

CAUTION

Do not spray solvent into the alternator, vacuum pump, starter, or air intakes.

- (3) Allow the solvent to remain on the engine from five to ten minutes. Then rinse the engine clean with additional solvent and allow it to dry.

CAUTION

Do not operate the engine until excess solvent has evaporated or otherwise been removed.

- (4) Remove the protective tape from the magnetos.
- (5) Lubricate the controls, bearing surfaces, etc., in accordance with the Lubrication Chart.

(b) Cleaning Landing Gear

Before cleaning the landing gear, place a plastic cover or similar material over the wheel and brake assembly.

- (1) Place a pan under the gear to catch waste.
- (2) Spray or brush the gear area with solvent or a mixture of solvent and degreaser, as desired. Where heavy grease and dirt deposits have collected, it may be necessary to brush areas that were sprayed, in order to clean them.
- (3) Allow the solvent to remain on the gear from five to ten minutes. Then rinse the gear with additional solvent and allow to dry.
- (4) Remove the cover from the wheel and remove the catch pan.
- (5) Lubricate the gear in accordance with the Lubrication Chart.

(c) Cleaning Exterior Surfaces

The airplane should be washed with a mild soap and water. Harsh abrasives or alkaline soaps or detergents could make scratches on painted or plastic surfaces or could cause corrosion of metal. Cover areas where cleaning solution could cause damage. To wash the airplane, use the following procedure:

- (1) Flush away loose dirt with water.
- (2) Apply cleaning solution with a soft cloth, a sponge or a soft bristle brush.
- (3) To remove exhaust stains, allow the solution to remain on the surface longer.
- (4) To remove stubborn oil and grease, use a cloth dampened with naphtha.
- (5) Rinse all surfaces thoroughly.
- (6) Any good automotive wax may be used to preserve painted surfaces. Soft cleaning cloths or a chamois should be used to prevent scratches when cleaning or polishing. A heavier coating of wax on the leading surfaces will reduce the abrasion problems in these areas.

(d) Cleaning Windshield and Windows

- (1) Remove dirt, mud and other loose particles from exterior surfaces with clean water.
- (2) Wash with mild soap and warm water or with aircraft plastic cleaner. Use a soft cloth or sponge in a straight back and forth motion. Do not rub harshly.
- (3) Remove oil and grease with a cloth moistened with kerosene.

CAUTION

Do not use gasoline, alcohol, benzene, carbon tetrachloride, thinner, acetone, or window cleaning sprays.

- (4) After cleaning plastic surfaces, apply a thin coat of hard polishing wax. Rub lightly with a soft cloth. Do not use a circular motion.
- (5) A severe scratch or mar in plastic can be removed by rubbing out the scratch with jeweler's rouge. Smooth both sides and apply wax.

(e) Cleaning Headliner, Side Panels and Seats

- (1) Clean headliner, side panels, and seats with a stiff bristle brush, and vacuum where necessary.
- (2) Soiled upholstery, except leather, may be cleaned with a good upholstery cleaner suitable for the material. Carefully follow the manufacturer's instructions. Avoid soaking or harsh rubbing.

CAUTION

Solvent cleaners require adequate ventilation.

- (3) Leather should be cleaned with saddle soap or a mild hand soap and water.

(f) Cleaning Carpets

To clean carpets, first remove loose dirt with a whisk broom or vacuum. For soiled spots and stubborn stains use a nonflammable dry cleaning fluid. Floor carpets may be removed and cleaned like any household carpet.

THIS PAGE INTENTIONALLY LEFT BLANK

TABLE OF CONTENTS

SECTION 9

SUPPLEMENTS

Paragraph/Supplement No.		Page No.
9.1	General	9-1
1	Air Conditioning System Installation	9-3
2	AutoFlite II Autopilot Installation	9-7
3	AutoControl IIIB Autopilot Installation	9-9
4	Piper Electric Pitch Trim	9-13

SECTION 9
SUPPLEMENTS

9.1 GENERAL

This section provides information in the form of Supplements which are necessary for efficient operation of the airplane when equipped with one or more of the various optional systems and equipment not provided with the standard airplane.

All of the Supplements provided by this section are "FAA Approved" and consecutively numbered as a permanent part of this Handbook. The information contained in each Supplement applies only when the related equipment is installed in the airplane.

THIS PAGE INTENTIONALLY LEFT BLANK

SUPPLEMENT 1

AIR CONDITIONING INSTALLATION

SECTION 1 - GENERAL

This supplement supplies information necessary for the efficient operation of the airplane when the optional air conditioning system is installed. The information contained within this supplement is to be used "as described" in conjunction with the complete handbook.

This supplement has been "FAA Approved" as a permanent part of this handbook and must remain in this handbook at all times when the optional air conditioning system is installed.

SECTION 2 - LIMITATIONS

- (a) To insure maximum climb performance the air conditioner must be turned "OFF" manually prior to takeoff to disengage the compressor and retract the condenser door. Also the air conditioner must be turned "OFF" manually before the landing approach in preparation for a possible go-around.
- (b) Placards
In full view of the pilot, in the area of the air conditioner controls when the air conditioner is installed:

"WARNING - AIR CONDITIONER MUST BE OFF TO INSURE
NORMAL TAKEOFF CLIMB PERFORMANCE."

In full view of the pilot, to the right of the engine gauges (condenser door light):

"AIR COND DOOR
OPEN"

SECTION 3 - EMERGENCY PROCEDURES

No changes to the basic Emergency Procedures provided by Section 3 of this Pilot's Operating Handbook are necessary for this supplement.

SECTION 4 - NORMAL PROCEDURES

Prior to takeoff, the air conditioner should be checked for proper operation as follows:

- (a) Check aircraft master switch "ON."
- (b) Turn the air conditioner control switch to "ON" and the fan switch to one of the operating positions - the "AIR COND DOOR OPEN" warning light will turn on, thereby indicating proper air conditioner condenser door actuation.
- (c) Turn the air conditioner control switch to "OFF" - the "AIR COND DOOR OPEN" warning light will go out, thereby indicating the air conditioner condenser door is in the up position.
- (d) If the "AIR COND DOOR OPEN" light does not respond as specified above, an air conditioner system or indicator bulb malfunction is indicated and further investigation should be conducted prior to flight.

The above operational check may be performed during flight if an in flight failure is suspected.

The condenser door light is located to the right of the engine instrument cluster in front of the pilot. The door light illuminates when the door is open and is off when the door is closed.

SECTION 5 - PERFORMANCE

Operation of the air conditioner will cause slight decreases in cruise speed and range. Power from the engine is required to run the compressor, and the condenser door, when extended, causes a slight increase in drag. When the air conditioner is turned off there is normally no measurable difference in climb, cruise or range performance of the airplane.

NOTE

To insure maximum climb performance the air conditioner must be turned off manually before takeoff to disengage the compressor and retract the condenser door. Also the air conditioner must be turned off manually before the landing approach in preparation for a possible go-around.

Although the cruise speed and range are only slightly affected by the air conditioner operation, these changes should be considered in preflight planning. To be conservative, the following figures assume that the compressor is operating continuously while the airplane is airborne. This will be the case only in extremely hot weather.

- (a) The decrease in true airspeed is approximately 4 KTS at all power settings.
- (b) The decrease in range may be as much as 32 nautical miles for the 48 gallon capacity.

The climb performance is not compromised measurably with the air conditioner operating since the compressor is declutched and the condenser door is retracted, both automatically, when a full throttle position is selected. When the full throttle position is not used or in the event of a malfunction which would cause the compressor to operate and the condenser door to be extended, a decrease in rate of climb of as much as 100 fpm can be expected. Should a malfunction occur which prevents condenser door retraction when the compressor is turned off, a decrease in rate of climb of as much as 50 fpm can be expected.

THIS PAGE INTENTIONALLY LEFT BLANK

SUPPLEMENT 2

AUTOFLITE II AUTOPILOT INSTALLATION

SECTION 1 - GENERAL

This supplement supplies information necessary for the operation of the airplane when the optional AutoFlite II Autopilot is installed. The information contained within this supplement is to be used "as described" in conjunction with the complete handbook.

This supplement has been "FAA Approved" as a permanent part of this handbook and must remain in this handbook at all times when the optional AutoFlite II Autopilot is installed.

SECTION 2 - LIMITATIONS

- (a) Autopilot use prohibited above 149 KIAS.
- (b) Autopilot "OFF" during takeoff and landing.

SECTION 3 - EMERGENCY PROCEDURES

- (a) In case of malfunction DEPRESS and hold Disconnect switch on pilot's control wheel.
- (b) Rocker switch on instrument panel "OFF."
- (c) Unit may be overpowered manually.
- (d) In climb, cruise or descent configuration a malfunction with a 3 second delay in recovery initiation may result in 45° bank and 180' altitude loss. Maximum altitude loss measured at 149 KIAS in a descent.
- (e) In approach configuration a malfunction with a 1 second delay in recovery initiation results in 18° bank and 10' altitude loss.

SECTION 4 - NORMAL PROCEDURES

- (a) Engagement
 - (1) Rocker Switch on instrument panel - ON.
 - (2) Disconnect Switch on left hand side of pilot's control wheel - RELEASED.
- (b) Disengagement
 - (1) Depress Disconnect Switch on pilot's control wheel (or)
 - (2) Rocker Switch on instrument panel - OFF.
- (c) Heading Changes
 - (1) Depress Disconnect Switch, make Heading Change, release Disconnect Switch.
 - (2) Move Trim Knob on instrument for Drift Correction from a constant heading.
 - (3) Move Turn Command Knob on instrument for right or left banked turns.

(d) OMNI Tracker

- (1) Center Turn Command Knob and push IN to engage Tracker.
- (2) Trim Knob - push IN for high sensitivity.

SECTION 5 - PERFORMANCE

No changes to the basic performance provided by Section 5 of this Pilot's Operating Handbook are necessary for this supplement.

SUPPLEMENT 3

NAQ

AUTOCONTROL IIIB AUTOPILOT INSTALLATION

SECTION 1 - GENERAL

This supplement supplies information necessary for the operation of the airplane when the optional Piper AutoControl IIIB Autopilot is installed. The information contained within this supplement is to be used "as described" in conjunction with the complete handbook.

This supplement has been "FAA Approved" as a permanent part of this handbook and must remain in this handbook at all times when the optional Piper AutoControl IIIB Autopilot is installed.

SECTION 2 - LIMITATIONS

- (a) Autopilot use prohibited above 149 KIAS.
- (b) Autopilot "OFF" during takeoff and landing.

SECTION 3 - EMERGENCY OPERATION

- (a) In an emergency the AutoControl IIIB can be disconnected by:
 - (1) Pushing the roll ON-OFF Rocker Switch "OFF."
 - (2) Pulling the Autopilot Circuit Breaker.
- (b) The autopilot can be overpowered at either control wheel.
- (c) An autopilot runaway, with a 3 second delay in the initiation of recovery while operating in a climb, cruise or descending flight, could result in a 45° bank and 180' altitude loss. Maximum altitude loss measured at 149 KTS in a descent.
- (d) An autopilot runaway, with a 1 second delay in the initiation of recovery, during an approach operation, coupled or uncoupled, could result in a 18° bank and 10' altitude loss.

SECTION 4 - NORMAL PROCEDURES

PREFLIGHT

- (a) AUTOPILOT
 - (1) Place Radio Coupler in "HDG" Mode (if installed) and place the AP "ON-OFF" switch to the "ON" position to engage roll section. Rotate roll command knob left and right and observe that control wheel describes a corresponding left and right turn, then center knob.
 - (2) Set correct compass heading on D.G. and turn HDG bug to aircraft heading. Engage "HDG" mode rocker switch and rotate HGD bug right and left. Aircraft control wheel should turn same direction as bug. Grasp control wheel and manually override servo, both directions.

(b) RADIO COUPLER (OPTIONAL)

- (1) Tune and identify VOR or VOT station. Position Radio Coupler to OMNI Mode. Engage Autopilot ROLL and HDG switches. Set HDG bug to aircraft heading and rotate O.B.S. to cause OMNI indicator Needle to swing left and right slowly. Observe that control wheel rotates in direction of needle movement.
- (2) Disengage AP "ON-OFF" switch. Reset Radio Coupler control to HDG.

IN-FLIGHT

- (a) Trim airplane (ball centered).
- (b) Check air pressure vacuum to ascertain that the directional gyro and attitude gyro are receiving sufficient air.
- (c) Roll Section.
 - (1) To engage, center ROLL knob, push AP "ON-OFF" switch to "ON" position. To turn, rotate console ROLL knob in desired direction. (Maximum angle of bank should not exceed 30°.)
 - (2) For heading mode, set directional gyro with magnetic compass. Push directional gyro HDG knob in, rotate bug to aircraft heading. Push console heading rocker (HDG) switch to "ON" position. To select a new aircraft heading, push D.G. heading knob "IN" and rotate, in desired direction of turn, to the desired heading.
- (d) Radio Coupling - VOR/ILS with Standard directional gyro. (Optional)
 - (1) For VOR Intercepts and Tracking:

Select the desired VOR course and set the HDG bug to the same heading. Select OMNI mode on the coupler and HDG Mode on the autopilot console.
 - (2) For ILS Front Course Intercepts and Tracking:

Tune the localizer frequency and place the HDG bug on the inbound, front course heading. Select LOC-NORM mode on the coupler and HDG mode on the autopilot console.
 - (3) For LOC Back Course Intercepts and Tracking:

Tune the localizer frequency and place the HDG bug on the inbound course heading to the airport. Select LOC-REV mode with coupler and HDG mode on the autopilot console.

SECTION 5 - PERFORMANCE

No changes to the basic performance provided by Section 5 of this Pilot's Operating Handbook are necessary for this supplement.

THIS PAGE INTENTIONALLY LEFT BLANK

ISSUED: JUNE 18, 1976

REPORT: VB-790
9-11

THIS PAGE INTENTIONALLY LEFT BLANK

SUPPLEMENT 4

PIPER ELECTRIC PITCH TRIM

SECTION 1 - GENERAL

This supplement supplies information necessary for the operation of the airplane when the optional Piper Electric Pitch Trim is installed. The information contained within this supplement is to be used "as described" in conjunction with the complete handbook.

This supplement has been "FAA Approved" as a permanent part of this handbook and must remain in this handbook at all times when the optional Piper Electric Pitch Trim is installed.

SECTION 2 - LIMITATIONS

No changes of the basic limitations provided by Section 2 of this Pilot's Operating Handbook are necessary for this supplement.

SECTION 3 - EMERGENCY PROCEDURES

- (a) In case of malfunction, ACTIVATE disconnect switch located above the ignition switch, to OFF position.
- (b) In case of malfunction, overpower the electric trim at either control wheel.
- (c) Maximum altitude change with a 4 second delay in recovery initiation is 800 feet and occurs in the descent configuration. Maximum altitude change in the approach configuration with a 4 second recovery delay is 100 feet.

SECTION 4 - NORMAL PROCEDURES

The electric trim system may be turned ON or OFF by a switch located above the ignition switch. The pitch trim may be changed when the electric trim system is turned on either by moving the manual pitch trim control wheel or by operating the trim control switch on the pilot's control yoke. To prevent excessive speed increase in the event of an electric trim run-away malfunction, the system incorporates an automatic disconnect feature which renders the system inoperative above approximately 143 KIAS. The disconnected condition does not affect the manual trim system.

SECTION 5 - PERFORMANCE

No changes to the basic performance provided by Section 5 of this Pilot's Operating Handbook are necessary for this supplement.

THIS PAGE INTENTIONALLY LEFT BLANK

TABLE OF CONTENTS

SECTION 10

OPERATING TIPS

Paragraph No.		Page No.
10.1	General	10-1
10.3	Operating Tips	10-1

SECTION 10
OPERATING TIPS

10.1 GENERAL

This section provides operating tips of particular value in the operation of the Cherokee Archer II.

10.3 OPERATING TIPS

- (a) Learn to trim for takeoff so that only a very light back pressure on the control wheel is required to lift the airplane off the ground.
- (b) The best speed for takeoff is about 53 KIAS under normal conditions. Trying to pull the airplane off the ground at too low an airspeed decreases the controllability of the airplane in the event of engine failure.
- (c) Flaps may be lowered at airspeeds up to 102 KIAS. To reduce flap operating loads, it is desirable to have the airplane at a slower speed before extending the flaps. The flap step will not support weight if the flaps are in any extended position. The flaps must be placed in the "UP" position before they will lock and support weight on the step.
- (d) Before attempting to reset any circuit breaker, allow a two to five minute cooling off period.
- (e) Before starting the engine, check that all radio switches, light switches and the pitot heat switch are in the off position so as not to create an overloaded condition when the starter is engaged.
- (f) Strobe lights should not be operating when flying through overcast and clouds, since reflected light can produce spacial disorientation. Do not operate strobe lights when taxiing in the vicinity of other aircraft.
- (g) The rudder pedals are suspended from a torque tube which extends across the fuselage. The pilot should become familiar with the proper positioning of his feet on the rudder pedals so as to avoid interference with the torque tube when moving the rudder pedals or operating the toe brakes.
- (h) In an effort to avoid accidents, pilots should obtain and study the safety related information made available in FAA publications such as regulations, advisory circulars, Aviation News, AIM and safety aids.
- (i) The shape of the wing fuel tanks is such that in certain maneuvers the fuel may move away from the tank outlet. If the outlet is uncovered, the fuel flow will be interrupted and a temporary loss of power may result. Pilots can prevent inadvertent uncovering of the outlet by avoiding maneuvers which could result in uncovering the outlet.

Extreme running turning takeoffs should be avoided as fuel flow interruption may occur.

Prolonged slips or skids which result in excess of 2000 ft. of altitude loss, or other radical or extreme maneuvers which could cause uncovering of the fuel outlet must be avoided as fuel flow interruption may occur when tank being used is not full.

- (j) Hand starting of the engine is not recommended, however, should hand starting of the engine be required, only experienced personnel should attempt this procedure. The magneto selector should be placed to "LEFT" during the starting procedure to reduce the probability of "Kick Back". Place the ignition switch to "BOTH" position after the engine has started.